



OPERATOR'S GUIDE FOR NX6100 WITH 10.4" COLOR TOUCHSCREEN

DESCRIPTION:





This document supplies the owner/operator with sufficient information to make appropriate changes to operating parameters associated with normal boiler plant needs. Items such as system setpoint adjustments e.g. temperature, pressure, PID adjustments and alarm corrective action and adjustments.

CONTENTS:

The following items are covered in this manual:

| | | |
|----------|---|----------|
| 1 | INTRODUCTION | 4 |
| 1.1 | GENERAL | 4 |
| 1.2 | PASSWORD | 4 |
| 2 | DESCRIPTION OF TOUCHSCREEN OPERATION | 5 |
| 2.1 | THE TOUCHSCREEN | 5 |
| 2.2 | TOUCHSCREEN POWER ON | 5 |
| 2.3 | THE OPERATION MODE LINE AND STATUS MESSAGES | 6 |
| 2.4 | TOUCHSCREEN OVERVIEW DISPLAY | 8 |
| 2.5 | TOUCHSCREEN LOCKOUT RESET (ALARM MUTE) FUNCTION | 8 |
| 2.6 | TOUCHSCREEN LED INDICATION | 9 |
| 2.7 | TOUCHSCREEN FUEL/PROFILE SELECT | 9 |
| 2.8 | TOUCHSCREEN 'CONTROL' SCREEN | 10 |
| 2.9 | TOUCHSCREEN 'MENU' BUTTON | 11 |
| 2.10 | TOUCHSCREEN 'BURNER SETTINGS' BUTTON | 11 |
| 2.11 | TOUCHSCREEN 'FAULT/EVENT LOG' BUTTON | 12 |



| | | |
|----------|--|-----------|
| 2.12 | TOUCHSCREEN ‘SCREEN CONFIGURATION’ BUTTON..... | 13 |
| 2.13 | CLEANING THE TOUCHSCREEN | 13 |
| 2.14 | TOUCHSCREEN COMMISSION MODE..... | 15 |
| 3 | SETPOINT, CUT IN/CUT OUT AND MODULATION OPTION PARAMETERS | 16 |
| 3.1 |  OPTION 21.0 – SET-POINT 1 ENABLE (0 - 1) LV1 | 17 |
| 3.2 |  <i>OPTION 21.1</i> – SET-POINT 1 CONTROL VALUE (0 - 999 / 00.0 - 99.9 / 0.00 - 9.99) LV1 | 17 |
| 3.3 |  OPTION 21.2 – SET-POINT 1 PROPORTIONAL BAND (0 - 999 / 00.0 - 99.9 / 0.00 - 9.99) LV1.. | 17 |
| 3.4 | OPTION 21.3 – SET-POINT 1 INTEGRAL TIME (0 – 999 SECONDS) LV1 | 17 |
| 3.5 | OPTION 21.4 – SET-POINT 1 DERIVATIVE TIME (0 – 999 SECONDS) LV1 | 18 |
| 3.6 |  OPTION 21.5 - SETPOINT 1 CONTROL LIMIT TYPE (0 - 2) LV3 | 18 |
| 3.7 | OPTION 21.6 - SETPOINT 1 LOW LIMIT CONTROL VALUE (CUT IN) (0 - 999 / 00.0 - 99.9 / 0.00 - 9.99) LV1..... | 19 |
| 3.8 | OPTION 21.7 - SETPOINT 1 HIGH LIMIT CONTROL VALUE (CUT OUT) (0 - 999 / 00.0 - 99.9 / 0.00 - 9.99) LV1... | 19 |
| 3.9 | OPTION 21.8 – REMOTE SETPOINT 1 ZERO (4MA) VALUE (0 - 999 / 00.0 - 99.9 / 0.00 - 9.99) LV1..... | 20 |
| 3.10 | OPTION 21.9 – REMOTE SETPOINT 1 SPAN (20MA) VALUE (0 - 999 / 00.0 - 99.9 / 0.00 - 9.99) LV1 | 20 |
| 3.11 | OPTION 22.0 – PID (SET-POINT) 2 ENABLE (0 - 1) LV1 | 20 |
| 3.12 | OPTION 22.1 – SET-POINT 2 CONTROL VALUE (0 - 999 / 00.0 - 99.9 / 0.00 - 9.99) LV1 | 20 |
| 3.13 | OPTION 22.2 – SET-POINT 2 PROPORTIONAL BAND (0 - 999 / 00.0 - 99.9 / 0.00 - 9.99) LV1..... | 20 |
| 3.14 | OPTION 22.3 – SET-POINT 2 INTEGRAL TERM (0 – 999 SECONDS) LV1..... | 20 |
| 3.15 | OPTION 22.4 – SET-POINT 2 DERIVATIVE TERM (0 - 100) LV1 | 21 |
| 3.16 | OPTION 22.5 - SETPOINT 2 CONTROL LIMIT TYPE (0 - 2) LV3 | 21 |
| 3.17 | OPTION 22.6 - SETPOINT 2 LOW LIMIT CONTROL VALUE (0 - 999 / 00.0 - 99.9 / 0.00 - 9.99) LV1..... | 21 |
| 3.18 | OPTION 22.7 - SETPOINT 2 HIGH LIMIT CONTROL VALUE (0 - 999 / 00.0 - 99.9 / 0.00 - 9.99) LV1 | 21 |
| 3.19 | OPTION 22.8 – REMOTE SETPOINT 2 ZERO (4MA) VALUE (0 - 999 / 00.0 - 99.9 / 0.00 - 9.99) LV1 | 21 |
| 3.20 | OPTION 22.9 – REMOTE SETPOINT 2 SPAN (20MA) VALUE (0 - 999 / 00.0 - 99.9 / 0.00 - 9.99) LV1 | 22 |
| 3.21 | OPTION 23.0 – WARMING ENABLE (0 OR 1) LV1 | 22 |
| 3.22 | OPTION 23.1 – WARMING LIMIT (0 - 999 / 00.0 - 99.9 / 0.00 - 9.99) LV1 | 22 |
| 3.23 | OPTION 23.2 – WARMING TIME (0 TO 999 MINUTES) LV1 | 22 |
| 4 | MANUAL MODULATION AND LOW FIRE HOLD..... | 22 |
| 4.1 | AUTO/MAN KEY LV1 | 22 |
| 4.2 | LOW FIRE HOLD LV1 | 23 |
| 5 | OPTIONS 24.X – SEQUENCING..... | 23 |
| 5.1 | OPTION 24.0 SEQUENCE SLAVES (NUMBER OF BOILERS) (0-3) LV1 | 24 |
| 5.2 | OPTION 24.1 -24.3 PRIORITY NUMBER(S) LV1 | 25 |
| 5.3 | OPTION 24.4 - <i>RESERVED</i> | 25 |
| 5.4 | OPTION 24.5 – LEAD (MASTER) BOILER SELECT METHOD LV1 | 25 |
| 5.5 | OPTION 24.6 – LAG (SLAVE) ON RATE (0-100%) LV1 | 26 |
| 5.6 | OPTION 24.7 – LAG (SLAVE) ON DELAY (0-999 MINUTES) LV1 | 26 |
| 5.7 | OPTION 24.8 – LAG (SLAVE) OFF RATE (0-100%) LV3 | 26 |
| 5.8 | OPTION 24.9 – LAG (SLAVE) OFF DELAY (0-999 MINUTES) LV3 | 26 |
| 5.9 | OPTION 25.0 – BANKING BASED ON TEMPERATURE LV3..... | 26 |
| 5.10 | OPTION 25.1 – WATER TEMPERATURE ZERO VALUE LV3 | 27 |
| 5.11 | OPTION 25.2 – WATER TEMPERATURE SPAN VALUE LV3 | 27 |
| 5.12 | OPTION 25.3 – WATER TEMPERATURE CUT-IN LV1..... | 27 |
| 5.13 | OPTION 25.4 – WATER TEMPERATURE CUT-OUT LV1 | 27 |
| 6 | RESETTING THE CONTROL..... | 27 |
| 7 | START-UP SEQUENCE..... | 28 |



| | | |
|-----------|---|-----------|
| 8 | FAULTS AND FAULT FINDING..... | 30 |
| 8.1 | THE FAULT DISPLAY | 30 |
| 8.2 | WHAT TO DO WHEN A FAULT OCCURS | 30 |
| 8.3 | NON-VOLATILE LOCKOUT..... | 31 |
| 8.4 | FAULT SUBSETS..... | 31 |
| 8.5 | FAULT LISTING | 31 |
| 8.6 | THE ENGINEER'S TAB..... | 41 |
| 8.7 | SYSTEM EVENT/FAULT HISTORY. | 41 |
| 8.8 | ENGINEER'S KEY PARAMETER LIST..... | 41 |
| 9 | TROUBLESHOOTING..... | 52 |
| 9.1 | DISPLAY / GENERAL..... | 52 |
| 9.2 | STARTUP | 53 |
| 9.3 | COMMISSIONING..... | 53 |
| 9.4 | GAS VALVE PROVING..... | 54 |
| 9.5 | MODULATION..... | 54 |
| 9.6 | INVERTERS..... | 55 |
| 9.7 | OXYGEN MEASUREMENT AND TRIM | 56 |
| 10 | PID TUTORIAL..... | 57 |
| 11 | COMBUSTION PROFILE SETUP GUIDELINE | 58 |
| 12 | FIREYE NX6100 EFFICIENCY CALCULATIONS..... | 59 |
| 13 | TYPICAL WIRING DIAGRAMS | 61 |



1 Introduction

This guide can be downloaded from the Fireeye web site at www.Fireeye.com. Search bulletins for NXOGTSD-6101 under the Nexus products family.

As an operator there are generally only a few items of interest as far as operating the Nexus NX6100. They are:

- Setting the system's operating pressure or temperature. (Section 3.6)
- Adjusting the cut in or cut out value. (Section 3.6)
- Manually modulating the boiler. (Section 4.1)
- Resetting the control after a safety shut down. (Section 2.5)
- Finding the Fault that caused the shut down. (Section 2.11)
- Changing Fuel/Profiles. (Section 2.7)

All of the other options and adjustments should be done by the combustion technician, as changes to certain parameters could result in an unsafe operating mode.

1.1 General

The Nexus touchscreen display allows the operator (or combustion technician) access to all setpoints and option parameters for commissioning and operating the Nexus NX6100.

1.2 Password

Several levels of passwords protect the integrity of the control. The only password an operator should require is the "site Passcode." This can be set as a number from 0-999. The factory default number is 154. The site Passcode can be changed if desired, however, this requires the use of a higher-level Passcode.

Warning: Should the Password be changed and forgotten, the NX6100 will have to be reprogrammed by using the higher-level Password. Until then, no adjustments are possible. Using the site Password, all options can be reviewed, but only a limited number can be changed

Password entry – Method one:

From the Touchscreen, press the Control button. This brings up the process control (see Section 2.8) where normal operating setpoints are adjusted. Press the desired value to change, such as the SP (setpoint) or CO (Cut Out), which will bring up the numeric keypad. Enter the site password (default is 154) and press OK. The numeric keypad will disappear and an open lock will appear on the top line of the display. Again press the Control button, press the desired value to change and use the up/down arrow keys to set the new value. The value is stored when you press the Set key. The Control will lock out requiring reentry of the password five minutes after the last keystroke.

Password entry – Method two:

From the Touchscreen, press the Menu button followed by the Burner Settings button. The Com key will appear in the bottom right of the Burner Settings screen. Press the Com key and enter the site password (default 154) on the numeric keypad. Press OK. Now, depending upon what parameter you want to change, you can press the Control key or press the Options tab on the Burner Settings screen.



To use the Options tab, you must scroll to the desired option, press the current value followed by the Set key. This will bring up the numeric keypad where you will enter the new value. Pressing OK will save the value. Note, the original value turns blue when you first press it, yellow to indicate a new value has been saved.

WARNING: If the default site password (154) has been change (using the full commissioning password) and forgotten, no values can be changed without the full password.

2 Description of Touchscreen operation.

2.1 The Touchscreen

The touchscreen provides all of the functions required to control and monitor the burner, it is also used to commission the control.

Once commissioning mode is selected the display background changes to red to alert the user that the control is in commissioning mode and therefore unable to monitor certain safety functions such as fuel air ratio positions.

2.2 Touchscreen Power on.

Initialization of the control and display will take approximately 16 seconds, during this initialization period the status LED will remain red. The display backlight will come on and the relays will be held in their no alarm state to avoid the possibility of nuisance alarms, which may otherwise occur.

Five (5) seconds after power is applied the Fireeye splash screen (shown below) will be displayed for 6 seconds, after which a period of 5 seconds of a blank white screen will show.



Once the initialization is complete the touchscreen will show the overview screen (shown in section 2.3) and the control will operate normally, changing the LED to green and relays to operate in line with the control status.

2.3 The Operation Mode line and Status messages

The line at the top of the screen displays the current burner: operating mode, profile, modulation mode and unit address. Burner status, and fault information, if applicable, is displayed in the bottom right corner of the display.

Dependent on the actual fault the audible alarm may be active and the control may move to safety shutdown.

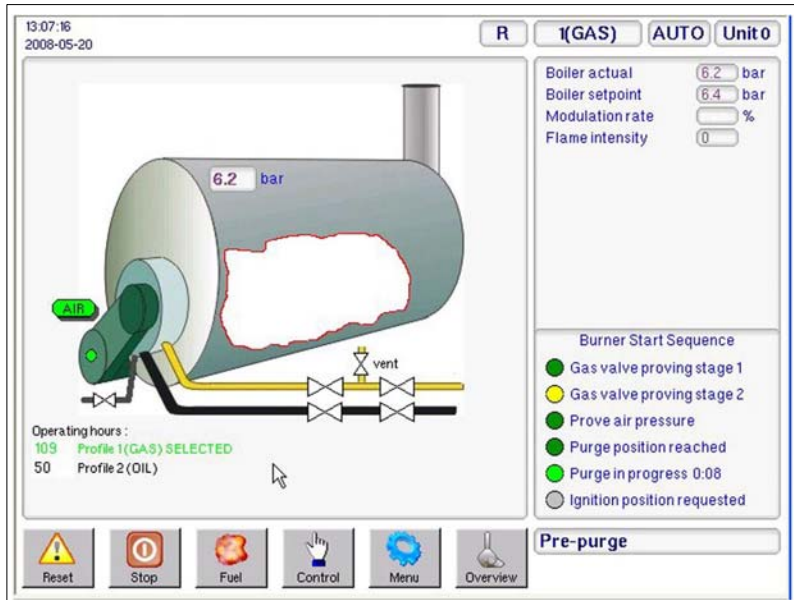

Dedicated 'buttons' at the lower edge of the screen perform the following functions:

Mute / Reset – used to reset a burner lockout, mute alarms or to test audible alarms. If an alarm is present the button is yellow and the text on the 'button' changes to Alarm Mute.

Burner Start/Stop – starts the burner, grayed out if the burner is already operating.



Fuel – allows selection of which fuel/profile is to be used, from a list of fuels/profiles available.

Control – used to enable selection of modulation mode, setpoint used, low fire hold, and make adjustments to normal operating parameters.

Menu – used to access configuration, adjustment modes.

Overview – returns screen to burner overview mode.

The following table shows the Icons that are displayed on the touchscreen above the information panels and their details.

| Icon | Description | Details |
|---|---------------------------------|--|
|  | State of CANbus connection | Displays when CANbus communication is faulty |
|  | State of Oxygen Interface | Displays when Oxygen Interface related fault is present. |
| COM | Indicates commissioning mode | Displays when the control is operating in commissioning mode. |
| MAN | Indicates HAND modulation mode. | Displays when the control is operating in HAND modulation mode. |
| AUTO | Indicates AUTO modulation mode. | Displays when the control is operating in AUTO modulation mode. |
| R / L(1) / L(2) | Indicates Boiler Setpoint mode | Displays Boiler setpoint selected, remote, local setpoint 1 or local setpoint 2. |
| 1 / 2 / 3 / 4 | Indicates profile selected | Displays the profile number for the selected profile. |
| 13:07:16 2008-05-20 | Indicates Time and Date | Displays Actual Time and Date, used for fault history and event logging. Date format is yyyy-mm-dd |

2.4 Touchscreen Overview display.

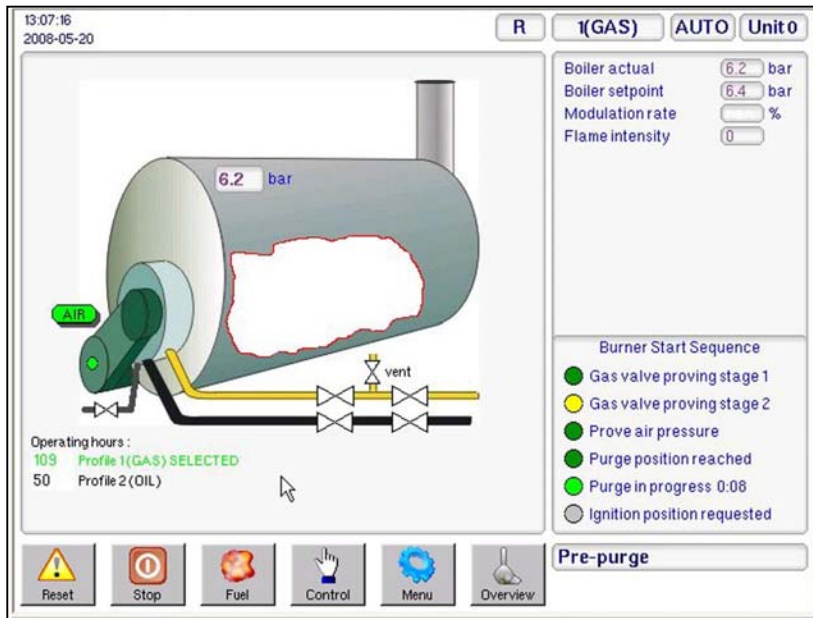

While the burner is changing 'status' the bottom-right one sixth of the display is used to provide a graphical indication of changing status.

The sequences displayed in this manner include, burner start-up, burner shutdown and fuel changeover.

In each case there is a 'lamp' for each stage, providing a ripple through lamp system to clearly indicate the progress of the change in burner 'status'.

The example shown in the picture is for the burner start-up sequence display.

Once the sequence is complete then the display will return, after a short delay, to the overview screen.

2.5 Touchscreen Lockout Reset (Alarm Mute) Function.

The **Reset** (Alarm Mute) 'button' on the touchscreen is multi-functional.

In normal operation it may be used to test the alarms, this is achieved by holding the button for in excess of 10 seconds after which the alarm relays will activate.

The **Reset** (Alarm Mute) button is also used to mute alarms and reset the control following a safety shutdown. If the alarm is sounding, the button will show the text **Mute**, pressing the button will mute (silence) the alarm, and then the text in the button will change to **Reset**, holding the button for greater than 3 seconds will allow the burner to restart if the faults have cleared. Further details of the functionality of this button are defined below.

There are three types of fault (alarm):

Alarm Only This will allow the burner to continue to operate, while the alarm is sounding.

If the **Reset** (Alarm Mute) button is pressed while the control is in this mode and the alarm is sounding the alarm will be muted and the burner will continue to operate.

Controlled Shutdown This will cause the burner to perform a controlled shutdown, and the alarm will sound, once the fault clears the burner will restart without the requirement for manual intervention.

If the **Mute/ Reset** button is pressed while the control is in this mode the alarm will be muted and the burner will remain in controlled shutdown.

If the **Mute/Reset** button is pressed after the control has restarted following a controlled shutdown the alarm will be muted and the burner will continue to operate.

Safety Shutdown This will cause the burner to perform a safety shutdown, and the alarm will sound, once the fault has cleared the burner will remain in safety shutdown until a **Mute/ Reset** is performed.

If the **Mute/ Reset** button is pressed while the control is in safety shutdown and the fault is still present the alarm will be muted and the burner will remain in safety shutdown. When the fault clears the alarm will sound once more.

If the **Mute/ Reset** button is pressed while the control is in safety shutdown and the fault has cleared the alarm will be muted and if the button is held for in excess of 3 seconds the burner will re-start.

2.6 Touchscreen LED Indication.

The Touchscreen also houses a multi-functional LED for indication of current status.

The LED will be green, permanently on, if no faults or limits are present.

The LED will be red, flashing, if there is a limit or an alarm condition present, which does not cause a lockout.

The LED will be red, permanently on, if there is a fault present, even if the fault has been muted, which causes a lockout.

2.7 Touchscreen Fuel/Profile Select.

Once the **Fuel** soft-button is pressed, a pop-up window appears on the right giving the user a choice of available fuels/profiles.

The NX6100 allows for a maximum of four profiles. Any profiles, which are not programmed and therefore not available, will be 'grayed-out'.

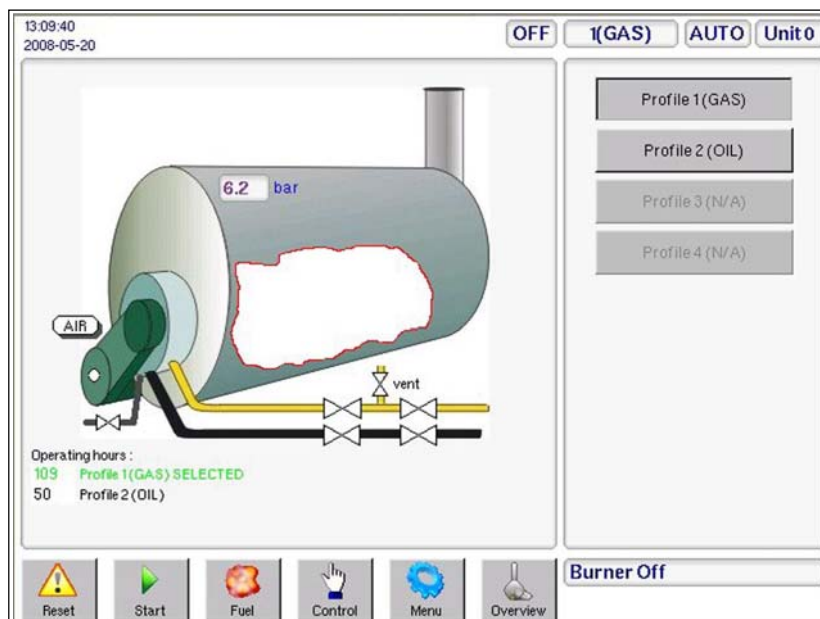

The 'Name' for each available profile will be either the default as set by the relevant option parameter or that entered via the Configuration Screen.

If the profile change is made while the burner is firing, there are two possibilities dependent on the options set in the control.

If the unit does not have the option to perform an online changeover enabled (switch profile without the burner going off) the burner will go through a controlled shutdown on the original profile and then restart on the new profile.

The online changeover allows a digital input to be configured to allow a profile swap without turning the burner off. If this input is ON and a fuel profile selection change is made, the control will go to low fire then back to pilot ignition (P2) on the original profile. It will then drop the main fuel valves and run with just the pilot on (and the ignition transformer if option parameter 14.6 is not set to 1). It will then move all drives to the P2 position of the new profile and open the appropriate main fuel valves.

To exit this operation window and return to the overview screen press the **Overview** button.

2.8 Touchscreen 'Control' screen.

Once the **Control** button is pressed, a window appears giving the user a choice of options. If an option is unavailable it will be 'grayed out', for example Manual Modulation may be disabled during commissioning.

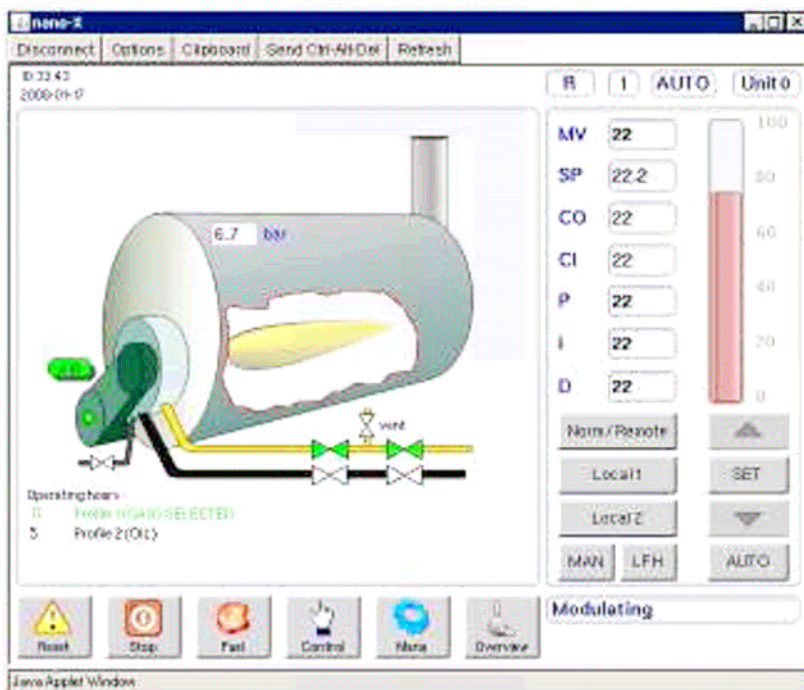

If the burner is firing, then the modulation percentage will be displayed on the vertical bar graph (0-100%), as well as numerically inside the box..

Using the buttons available from this window will change the way the burner is operating.

To exit this control mode window and return to the overview screen use the **Overview** button.

2.9 Touchscreen 'Menu' button.

Once the **Menu** button is pressed, a pop-up window appears on the right giving the user a choice of options. If an option is unavailable it will be 'grayed out'.

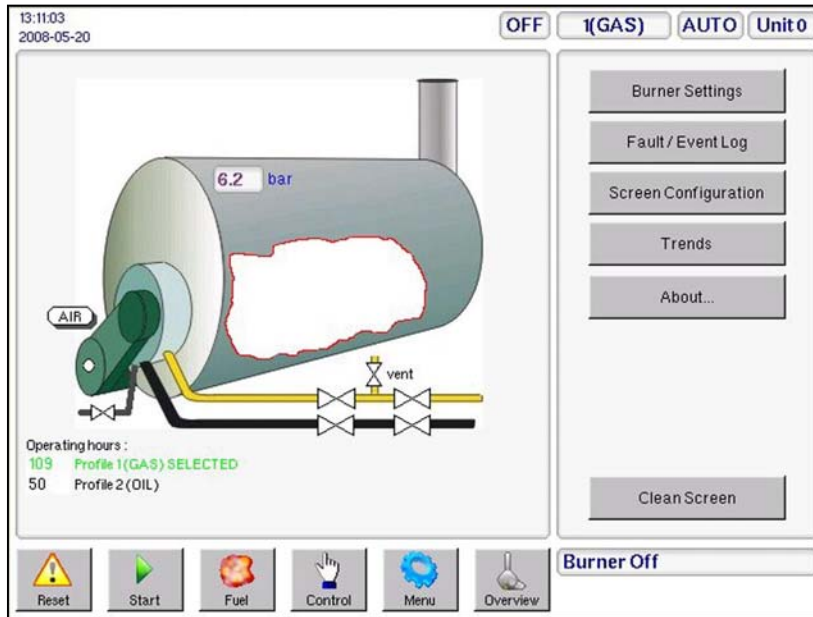

Using the buttons available after pressing the **Menu** button will generate a new pop-up window in the left hand area of the screen.

To exit this operation window and return to the overview screen press the **Overview** button.

Settings' button.

2.10 Touchscreen 'Burner

Once the **Burner Settings** button is pressed, a window appears giving the user a choice of data types by Tab. Selecting, by touching a tab, it is possible to view a variety of data, in the example here the Option Parameters are available.

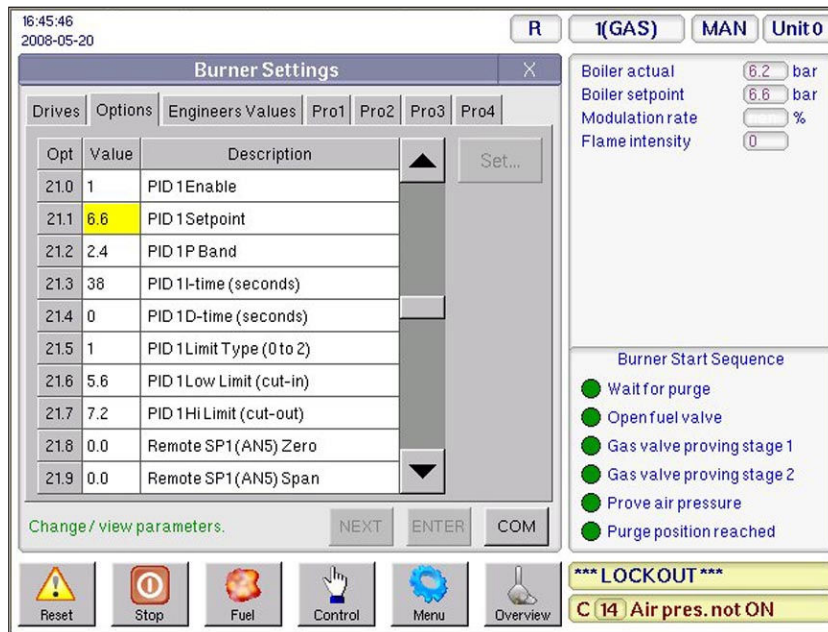

In the following example the Engineers Key values are displayed. The scroll bar at the side of the data tab allows the user to move up and down the table.

The screenshot shows the 'Burner Settings' window. At the top, it displays the time '16:48:35' and date '2008-05-20'. The window is divided into several sections:

- Top Right:** Control buttons for 'R', '(GAS)', 'MAN', and 'Unit 0'.
- Right Panel:** Displays boiler parameters: 'Boiler actual' (6.2 bar), 'Boiler setpoint' (6.6 bar), 'Modulation rate' (0%), and 'Flame intensity' (0).
- Bottom Right:** 'Burner Start Sequence' with a list of steps: 'Wait for purge', 'Open fuel valve', 'Gas valve proving stage 1', 'Gas valve proving stage 2', 'Prove air pressure', and 'Purge position reached'.
- Bottom:** A row of icons for 'Reset', 'Stop', 'Fuel', 'Control', 'Menu', and 'Overview'. A yellow warning banner reads '*** LOCKOUT ***' and 'C 14 Air pres. not ON'.
- Main Table:** A table with columns 'EK', 'Value', and 'Description'. It lists 19 items, including digital inputs, burner select, air flow input, and boiler status.

2.11 Touchscreen 'Fault/Event Log' button.

Once the **Fault/Event Log** button is pressed, a window appears showing the Fault/Event history. Users may select to see Fault data only, Events data only or a combined history as shown in this example. For more information on fault codes and fault finding refer to the Fault Finding section of the NX6100 manual – Fireye bulletin NEX-6101.

The screenshot shows the 'Fault / Event Log' window. At the top, it displays the time '15:14:11' and date '2008-05-21'. The window is divided into several sections:

- Top Right:** Control buttons for 'R', '()', 'MAN', and 'Unit 0'.
- Right Panel:** Displays boiler parameters: 'Boiler actual' (6.2 bar), 'Boiler setpoint' (6.6 bar), 'Modulation rate' (1%), and 'Flame intensity' (99).
- Bottom Right:** 'Burner Start Sequence' with a list of steps: 'Ignition active', 'Pilot ignition interval', 'Main ignition', 'Wait for flame established', 'Moving to low fire', and 'Modulation'.
- Bottom:** A row of icons for 'Reset', 'Stop', 'Fuel', 'Control', 'Menu', and 'Overview'. A status bar at the bottom indicates 'Modulating'.
- Main Table:** A table with columns 'Item', 'Date / Time', 'Description', 'Sbst.', 'Pro.', and 'SP'. It lists various events such as 'Enter COMMISSION mode', 'Burner shutdown', 'Switched OFF', 'Burner startup', and 'Air pres. not ON'.

2.12 Touchscreen 'Screen Configuration' button.

Once the Screen **Configuration** button is pressed, a window appears giving the user a choice of options. From the General Tab a name may be entered for each profile in use.



Highlight the profile for which a name is to be entered or modified and press the Modify button. This will cause a window to appear allowing the required name to be entered using the button pad.

Once the name is displayed against the required profile the mode can be exited by pressing the 'X' in the top right corner of the Touchscreen Configuration window.

To exit this configuration window and return to the overview screen press the **Overview** button.

2.13 Cleaning the Touchscreen



WARNING

To prevent possible damage to the touchscreen, ensure the correct 'fluid' is used when cleaning the screen.

Before attempting to clean the screen ensure the clean screen function is enabled to ensure operation of the burner is not affected

Once the 'Clean Screen' function is selected the display keys will be unavailable for 20 seconds

Before attempting to clean the screen it is essential to select the **Clean Screen** function to prevent any pressure applied to clean the touchscreen being 'seen' as a 'button press'. The function can be accessed by selecting the **Menu** button at the base of the touchscreen and then, selecting **Clean Screen** from the list of functions available.

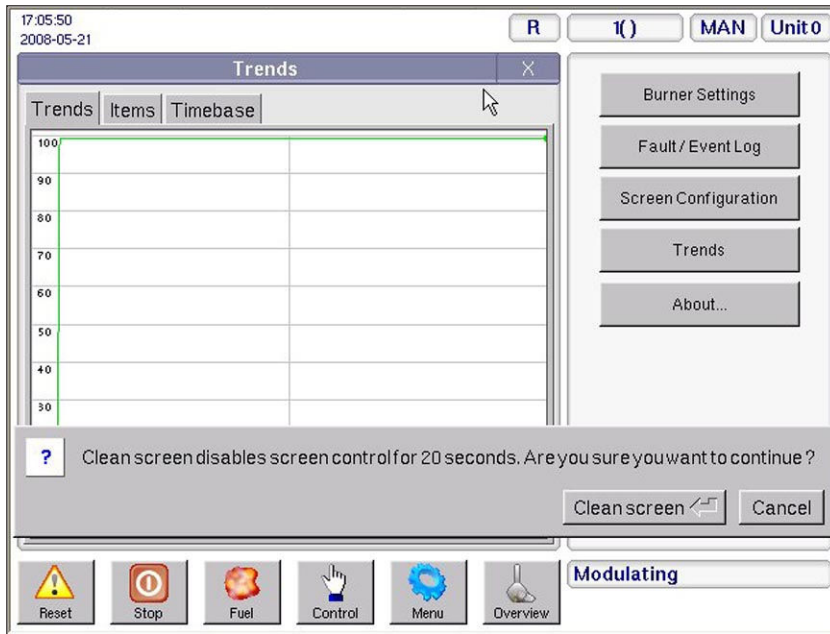

When cleaning the touchscreen ensure the correct LCD screen cleaner is used. Use of any other cleaning fluid or water may damage the screen.

There are designated commercial cleaning solutions on the market for touchscreens only. Also, these products are recommended to be used only with a very soft cloth. Please note the directions and the warnings on the product.



CAUTION

- Do NOT use any ammonia-based window cleaner. These chemical cleaners can ruin the touchscreen surface.
- Do NOT use any abrasive rags, towels or paper towels. An abrasive towel can scratch the touchscreen.

2.14 Touchscreen Commission mode.

To allow Option Parameters or Drives to be adjusted it is necessary to enter the relevant access passcode.

To enter the passcode press the **COM** button. This will prompt the keypad pane to appear, allowing the relevant passcode to be entered using the soft keypad and confirmed by pressing the **OK** button.

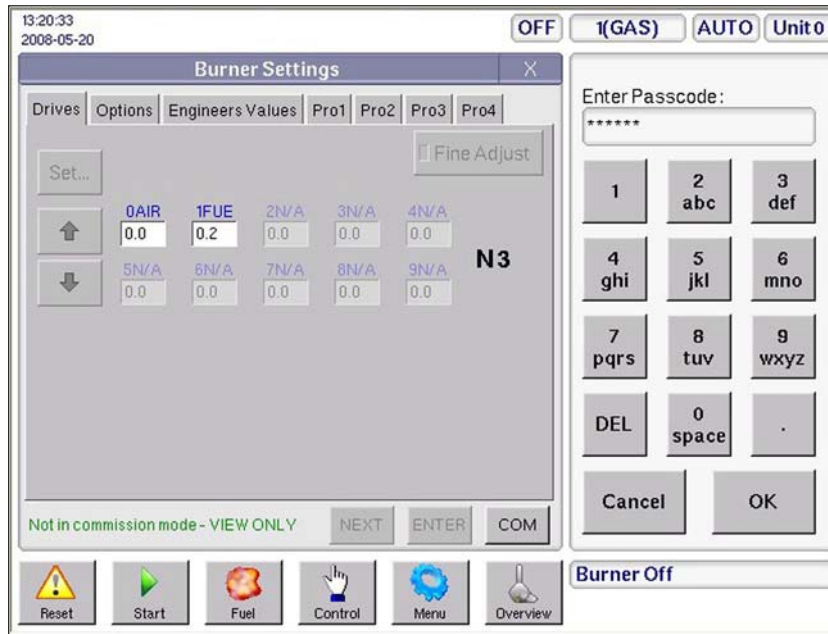

CAUTION

- Use extreme care while commissioning the system. While operating in commissioning mode the safety of the system is the sole responsibility of the commissioning engineer.
- Ensure a pre-purge position is entered for the relevant drives.
- Incorrect positioning of either fuel or air could cause a hazardous situation to occur.
- If the servo-motor positions have been up-loaded it is essential that the combustion is verified at each firing position to ensure a hazardous condition cannot occur, and for the data to be stored in the control.
- It is recommended that the close position for each servo motor is re-entered as part of the burner service regime, to compensate for wear in the servo-motor micro-switch during operation.
- Once all profile positions have been adjusted/entered it is essential that all profile points are checked to verify that the fuel air ration is acceptable for the appliance being controlled.

Once the correct passcode is entered the unit will enter commissioning mode and allow the option parameters and profile points to be adjusted, the text on the **COM** button will change to **RUN**. To warn the 'user' that the unit is in commissioning mode the overall display background changes to red and COM is displayed top-center on the screen

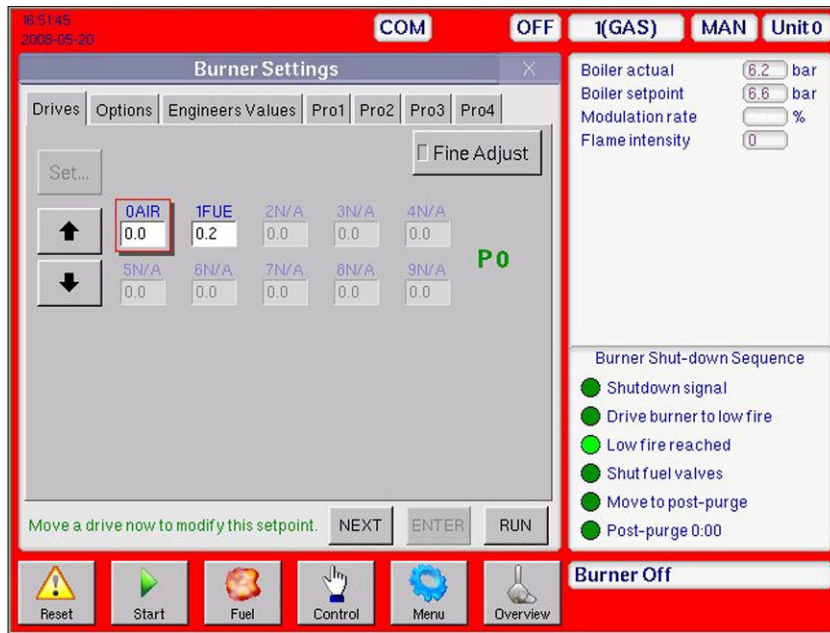

3 Setpoint, Cut In/Cut Out and Modulation Option Parameters

NOTE: For the following Options 21.x and 22.x, see Section 10 for PID Tutorial.

Setpoint/Modulation entry – Method one:

From the Touchscreen, press the Control button. This brings up the process control where normal operating setpoints are adjusted (See Touchscreen section 2.8). Press the desired value to change, such as the SP (setpoint) which will bring up the numeric keypad. Enter the site password (default is 154) and press OK. The numeric keypad will disappear and an open lock will appear on the top line of the display. Again press the Control button, press the desired value to change and use the up/down arrow keys to set the new value. The value is stored when you press the Set key. The Control will lock out requiring reentry of the password five minutes after the last keystroke.

Setpoint/Modulation entry – Method two:



From the Touchscreen, press the Menu button followed by the Burner Settings button (See Touchscreen Section 2.10). The Com key will appear in the bottom left of the Burner Settings screen. Press the Com key and enter the site password (default 154) on the numeric keypad. Press OK. Now, depending upon what parameter you want to change, you can press the Control key or press the Options tab on the Burner Settings screen.

To use the Options tab, you must scroll to the desired option, press the current value followed by the Set key. This will bring up the numeric keypad where you will enter the new value. Pressing OK will save the value. Note, the original value turns blue when you first press it, yellow to indicate a new value has been saved.

NOTE: If the default site password (154) has been change (using the full commissioning password) and forgotten, no values can be changed without the full password.

3.1  **Option 21.0 – Set-point 1 enable (0 - 1) LV1**

This option parameter is used to enable setpoint 1. (Option 22.0 for setpoint 2)

3.2  **Option 21.1 – Set-point 1 control value (0 - 999 / 00.0 - 99.9 / 0.00 - 9.99) LV1**

This is the desired pressure or temperature control value used in the PID control loop for setpoint 1. When the control is in auto mode, the PID control loop will modulate the boiler to maintain the measured value at the same level as set by this parameter.

3.3  **Option 21.2 – Set-point 1 proportional band (0 - 999 / 00.0 - 99.9 / 0.00 - 9.99) LV1**

This is the width of the proportional (modulation) band that is used by the PID control loop for setpoint 1. For example, if the setpoint was 100 psi, and this term was set to 10 psi, then the proportional band would be from 90 psi to 100 psi. A measured value of 90 psi would give high fire, and 100 psi would give low fire, assuming no integral or derivative terms were entered.

A value of 0 means no proportional band – the burner would stay at low fire until the high limit (Cut Out) is reached, then turn off. Proportional control is therefore needed to allow the burner to modulate.

3.4 **Option 21.3 – Set-point 1 integral time (0 – 999 seconds) LV1**

This is the integral time used in the PID control loop for setpoint 1. It may be set to any value from 0 to 999, seconds. If a value of 0 is entered the integral function is disabled, otherwise the time entered is the number of seconds the control will take to give an additional modulation change equal to that currently given by the proportional term. The lower the number (apart from zero), the more affect the integral function has. A large number will cause the integral term to act very slowly.



Integral control is required for the burner to accurately reach its setpoint.

3.5 Option 21.4 – Set-point 1 derivative time (0 – 999 seconds) LV1

This is the derivative time used in the PID control loop for setpoint 1. It may be set to any value from 0 to 999. A value of zero will disable the derivative function. A non-zero value will have the effect of ‘advancing’ the modulation rate change caused by a constantly changing measured value by the number of seconds given. A low value will have little effect; a large value will cause a large effect.

Derivative control is seldom needed for boilers, but can improve the response of the modulation system to sudden load changes. Too much can cause control instability.

3.6 Option 21.5 - Setpoint 1 control limit type (0 - 2) LV3

This option parameter defines the control limit type for setpoint 1. The control limits are used to automatically turn the burner off when it is not needed, and bring it back on when it is needed.

| Option parameter 21.5 value | Meaning |
|--------------------------------|--|
| 0 | No limits. The burner will run until another method is used to switch it off. |
| 1 | Absolute limit. The values entered in option parameters 21.6 and 21.7 are the actual limit values. |
| 2 | Deviation limit. The values entered in option parameters 21.6 and 21.7 represent a deviation (i.e. offset) from the setpoint 1 control value. This means that if the setpoint control value is changed, the limits are automatically changed correspondingly. |

The following are examples of Deviation and Absolute limit. These examples assume the user is using Method Two approach (from Password entry in section 1.2). Alternately, method one can also be used.

Deviation Example – setting Opt 21.5 to 2

To maintain 100 psi on the boiler, cut out at 115 psi, cut in at 95 psi.

NOTE: Opt 15.5 – Boiler High Safety Limit – If this option is set to a non-zero, *exceeding* this value causes a *non-volatile lockout*.

Opt 21.1 Setpoint (22.1)* set to 100 psi
 Opt 21.5 Control Type set to 2
 Opt 21.6 Cut In (22.6)* set to 5
 Opt 21.7 Cut Out (22.7)* set to 15

RESULTS:

Boiler OFF (Cut Out) at 115 psi
 Boiler ON (Cut In) at 95 psi



Boiler maintains (Setpoint)100 psi via PID

Changing ONLY the Setpoint –

Opt 21.1 (22.2) change to 60 psi

NEW RESULTS from Setpoint Change:

Boiler OFF (Cut Out) at.... 75 psi

Boiler ON (Cut In) at 55 psi

Boiler maintains (Setpoint)60 psi via PID

NOTE: NEW I (integral time) and D (derivative time) values - Option Parameters 21.3(22.3) and 21.4(22.4), may be required to achieve desired results.

Absolute Example – setting Opt 21.5 to 1:

Opt 21.1 Setpoint (22.1)*set to..... 100 psi

Opt 21.5 Control Type.....set to..... 1

Opt 21.6 Cut In (22.6)*set to..... 95

Opt 21.7 Cut Out (22.7)*set to..... 115

RESULTS:

Boiler OFF (Cut Out) at.... 115 psi

Boiler ON (Cut In) at 95 psi

Boiler maintains (Setpoint)100 psi via PID

Changing ONLY the Setpoint –

Opt 21.1 (22.2) change to 60 psi

NEW RESULTS from Setpoint Change:

Boiler OFF (Cut Out) at.... 115 psi

Boiler ON (Cut In) at 95 psi

Boiler maintains (Setpoint)..... 60 psi via PID

NOTE: NEW Cut In and Cut Out values as well as new I (integral time) and D (derivative time) values - Option Parameters 21.3(22.3) and 21.4(22.4), may be required to achieve desired results.

In BOTH examples (*) represents PID2

3.7 Option 21.6 - Setpoint 1 low limit control value (Cut In) (0 - 999 / 00.0 - 99.9 / 0.00 - 9.99) LV1

If the boiler is off due to a controlled shutdown, this parameter defines the measured value at which the boiler will be turned on again.

3.8 Option 21.7 - Setpoint 1 high limit control value (Cut Out) (0 - 999 / 00.0 - 99.9 / 0.00 - 9.99) LV1



If the boiler is on and firing, this parameter defines the measured value at which the boiler will be turned off via a controlled shutdown.

3.9 Option 21.8 – Remote Setpoint 1 zero (4ma) value (0 - 999 / 00.0 - 99.9 / 0.00 - 9.99) LV1

This is the zero value for the remote setpoint function specified by option parameter 20.7.

3.10 Option 21.9 – Remote Setpoint 1 span (20mA) value (0 - 999 / 00.0 - 99.9 / 0.00 - 9.99) LV1

This is the span value for the remote setpoint function specified by option parameter 20.7.

3.11 Option 22.0 – PID (set-point) 2 enable (0 - 1) LV1

This option parameter is used to select setpoint 2.

3.12 Option 22.1 – Set-point 2 control value (0 - 999 / 00.0 - 99.9 / 0.00 - 9.99) LV1

This is the control value used in the PID control loop for setpoint 2. When the control is in auto mode, the PID control loop will modulate the boiler to maintain the measured value at the same level as set by this parameter.

3.13 Option 22.2 – Set-point 2 proportional band (0 - 999 / 00.0 - 99.9 / 0.00 - 9.99) LV1

This is the width of the proportional (modulation) band that is used by the PID control loop for setpoint 2. For example, if the setpoint was 100 psi, and this term was set to 10 psi, then the proportional band would be from 90 to 100 psi. A measured value of 90 psi would give high fire, and 100 psi would give low fire, assuming no integral or derivative terms were entered.

A value of 0 means no proportional band – the burner would stay at low fire until the high limit (Cut Out) is reached, then turn off. Proportional control is therefore needed to allow the burner to modulate.

3.14 Option 22.3 – Set-point 2 integral term (0 – 999 seconds) LV1

This is the integral time used in the PID control loop for setpoint 2. It may be set to any value from 0 to 999, seconds. If a value of 0 is entered the integral function is disabled, otherwise the time entered is the number of seconds the control will take to give an additional modulation change equal to that currently given by the proportional term. The lower the number (apart from zero), the more affect the integral function has. A large number will cause the integral term to act very slowly.

Integral control is required for the burner to accurately reach its setpoint.



3.15 Option 22.4 – Set-point 2 derivative term (0 - 100) LV1

This is the derivative time used in the PID control loop for setpoint 2. It may be set to any value from 0 to 999. A value of zero will disable the derivative function. A non-zero value will have the effect of ‘advancing’ the modulation rate change caused by a constantly changing measured value by the number of seconds given. A low value will have little effect; a large value will cause a large effect.

Derivative control is seldom needed for boilers, but can improve the response of the modulation system to sudden load changes. Too much can cause control instability.

3.16 Option 22.5 - Setpoint 2 control limit type (0 - 2) LV3

This option parameter defines the control limit type for setpoint 2. The control limits are used to automatically turn the burner off when it is not needed, and bring it back on when it is needed.

| Option parameter 22.5 value | Meaning |
|--------------------------------|--|
| 0 | No limits. The burner will run until another method is used to switch it off. |
| 1 | Absolute limit. The values entered in option parameters 22.6 and 22.7 are the actual limit values. |
| 2 | Deviation limit. The values entered in option parameters 22.6 and 22.7 represent a deviation (i.e. offset) from the setpoint 1 control value. This means that if the setpoint control value is changed, the limits are automatically changed correspondingly. |

3.17 Option 22.6 - Setpoint 2 low limit control value (0 - 999 / 00.0 - 99.9 / 0.00 - 9.99) LV1

If the boiler is off due to a controlled shutdown, this parameter defines the measured value at which the boiler will be turned on again.

3.18 Option 22.7 - Setpoint 2 high limit control value (0 - 999 / 00.0 - 99.9 / 0.00 - 9.99) LV1

If the boiler is on and firing, this parameter defines the measured value at which the boiler will be turned off via a controlled shutdown.

3.19 Option 22.8 – Remote Setpoint 2 zero (4mA) value (0 - 999 / 00.0 - 99.9 / 0.00 - 9.99) LV1

This is the zero value for the remote setpoint function specified by option parameter 20.7.



3.20 Option 22.9 – Remote Setpoint 2 span (20mA) value (0 - 999 / 00.0 - 99.9 / 0.00 - 9.99) LV1

This is the span value for the remote setpoint function specified by option parameter 20.7.

3.21 Option 23.0 – Warming Enable (0 or 1) LV1

This parameter allows a warming function to be applied to the boiler, and makes option parameters 23.1 and 23.2 available. If zero is entered, no warming limit is applied.

3.22 Option 23.1 – Warming Limit (0 - 999 / 00.0 - 99.9 / 0.00 - 9.99) LV1

If, when the burner starts up and reaches modulation, the measured pressure / temperature value is lower than that specified here, the control will hold the boiler at low fire until the value specified is reached. The control will hold the boiler at low fire (in status 15) indefinitely unless a non-zero time has been entered in option parameter 23.2.

Note: If during normal modulation, the measured value falls below this limit having once been above it, the warming function will not be re-applied. The warming function is only applied on a burner start-up.

3.23 Option 23.2 – Warming Time (0 to 999 minutes) LV1

This parameter specifies a maximum time to hold the burner at low fire for, before ignoring the warming limit and allowing normal modulation.

Additionally, when the burner goes off (for any reason other than power interruption), and the measured value falls below the warming limit, the warming function will not be activated again until this time has passed.

NOTE: Further parameters (up to 29.9) may be available here if they are part of a users program or non-standard manufacturers program.

4 Manual Modulation and Low Fire Hold

4.1 AUTO/MAN key LV1

Pressing **AUTO/MAN** key toggles the burner in and out of manual or automatic modulation. To place the boiler in manual from automatic no password is required.

1. Press the **AUTO/MAN** key
2. Use the up/down arrow keys to set the firing rate.
3. Press the **AUTO** key to place in automatic



Note: The firing rate will be shown on the display. This function can be disabled via option parameter 1.1. To do so requires the suppliers (highest) passcode.

4.2 Low Fire Hold LV1

Pressing the **Low Fire Hold** button will return burner to low fire and remain there.. To exit press the **AUTO** button.

5 Options 24.x – Sequencing

Sequencing (lead/lag) is managed by using the “setpoint select” function internally to choose between Setpoint 1 and Setpoint 2 via the communications bus between NX6100’s. The “lead” or “master” boiler controls the “lag” or “slave” boiler(s) by switching them from setpoint 2 (“lag stand by” or “banking”) to the setpoint 1 values, and turns on based on Option 24.6 (lag (slave) On Rate) value. The lead boiler will override the modulation rate of the last lag boiler to come on and cause it to modulate in unison with the lead (master) boiler. If both the lead (master) boiler and last lag (slave) boiler remain above the Option 24.6 value another lag (slave) boiler will be started after Option 24.7 (lag (slave) on delay) value has expired. Other lags (slaves) that are on will remain at high fire until the last lag is turned off. At this point, the next lag boiler will begin to modulate with the lead (master) and so on until the lead (master) is carrying the load. The sequence in which boilers are turned on is set in Option 24.1-24.3 via communications addresses of each NX6100. When a lead (master) boiler is deselected as lead (master) and Option 24.0 has not been changed to 0, the boiler remains as lead (master) until a new lead (master) takes control. Once the new lead (master) takes control, the previous lead (master) may be turned off based on the demand and Option 24.1-24.3 settings.

If the lead (master) boiler is turned off, or fails to come on within three minutes, while operating as the lead, sequencing will be disabled and all lag (slave) boilers will revert to their own PID settings. Should a lag boiler fail to come on within three minutes, or the NX6100 is faulted, sequencing will immediately call for the next lag in the priority list.

If the lead (master) boiler is switched to manual modulation it will remain as lead bringing on lag (slave) boilers as required. This will allow the operator to “base load” a lead boiler if required.

The NX6100 can be the “master” (lead) boiler in a system that has PPC5000 or NX3100/4100 series as the communications message are the same. The NX6100 cannot be controlled by the PPC5000 or NX3100/4100 series controls as a boiler.

Stand by or Banking values

The “lag stand by” or “banking” temperature or pressure is entered as PID 2 or Setpoint 2 values however, options 22.2, 22.3, 22.4 (the P, I and D) values are unnecessary as the burner will start and remain at low fire until the “lag stand by” or “banking” cut out is reached. These values will be entered by;

1. Setting option parameter 22.0 to 1 (Enable Setpoint 2)
2. Setting option parameter 22.1 to the desired setpoint value when in stand by.
3. Setting option parameter 22.5 to 1 (Absolute Value)
4. Setting option parameter 22.6 to the desired cut in value when in stand by.
5. Setting option parameter 22.7 to the desired cut out value when in stand by.



For example: If the normal operating setpoint is 100 PSI, and the desired stand by pressure is 75 PSI. The setup would be:

| Option Parameter | Setting |
|------------------|----------------------------------|
| 22.0 | 1 |
| 22.1 | 75 |
| 22.5 | 1 |
| 22.6 | 75 (cut in or minimum pressure) |
| 22.7 | 80 (cut out or maximum pressure) |

STANDBY WATER TEMPERATURE FOR STEAM BOILER

If a steam boiler is being banked based on boiler temperature, a temperature sensor must be fitted into the boiler water jacket. The temperature sensor must be a 4-20mA device. If this device is to be loop-powered by the NX6100, it should be connected to the 30V output, "sensor supply" on PA16 and PA15. See option 25.0 – 25.4.

Example:

| | | |
|-----------------------------|-----------------|------|
| Fireye Temp. Sensor – TS350 | NX6100 | |
| Sensor Terminal (1) 4-20mA | NX6100 Terminal | PA16 |
| Sensor Terminal (2) Current | NX6100 Terminal | PA15 |

The language program needs to be 15 or higher.
EK200 shows the current version

Option/Parameters

20.7 = 0 Using AUX. input 5
25.0 = 5, AUX 5 input
25.1 = 32, Zero value of temp. sensor
25.2 = 350, Span value of temp. sensor
25.3 = Cut-in temp.
25.4 = Cut-out temp.

No PID involved, lag boiler will turn on and off on low fire.

Relevant Engineers Keys:

EK136, 0 = inactive. Only active when held off by the lead boiler.
EK159, Actual water temp.

NOTE: When using sequencing, setpoint 2 is unavailable for use with any digital input unless the boiler is removed from sequencing completely.

5.1 Option 24.0 Sequence Slaves (number of boilers) (0-3) LV1

This option is set to 1, 2 or 3 in each NX6100 to equal the number of lag "slave" boilers in the system. Once set, option parameters 24.1, 24.2, and 24.3 will become available. If the value is set to 0 the boiler will be taken out of sequencing and operate on its own PID. **OPTION PARAMETER 00.6 MUST BE SET TO 0 FOR SEQUENCING TO OPERATE**



5.2 Option 24.1 -24.3 Priority Number(s) LV1

The order in which boilers sequence on is entered as the communication address(s) of the boilers in **Options 24.1, 24.2 and 24.3**. The first to be turned on will have a priority number one above that of the lead boiler.

For example: If the communications address of the four boilers were 1, 2, 3, and 4 (**set in Option 0.2**), boiler 1 master (lead), with the following entered in **Options 24.1-24.3**

| Option parameter 24.x value | Comms. Address | Boiler |
|--------------------------------|----------------|--------|
| 24.1 | 2 | 2 |
| 24.2 | 3 | 3 |
| 24.3 | 4 | 4 |

The sequencing order would be boiler 2, 3 and 4. If boiler 2 were set to lead via **Option 24.5**, the order would be boiler 3, 4 and 1. Setting boiler 3 to master (lead), the order would be boiler 4, 1 and 2. Other sequencing orders can be achieved by changing the communications address entered in **Options 24.1-24.3**.

Note: Communications addresses should be changed while the boilers are not in sequencing (more than one boiler on) so as not to disrupt operation.

5.3 Option 24.4 - Reserved

5.4 Option 24.5 – Lead (master) Boiler Select Method LV1

This option parameter selects the lead (master) boiler via the keypad, digital input or communications (Comfire 2). The values are:

- 0 = Not lead, operates on own PID or as commanded by master (lead)
- 1 = lead (master) via Keypad
- 2 = lead (master) via digital input. (**Digital Input Selected via Option 20.8**)
- 3 = lead (master) via communications such as Comfire 2.

Note: When a lead (master) boiler is deselected as lead (master) and Option 24.0 has not been changed to 0, the boiler remains as lead (master) until a new lead (master) takes control. Once the new lead (master) takes control, the previous lead (master) may be turned off based on the demand and Option 24.1-24.3 settings.



5.5 Option 24.6 – lag (slave) On Rate (0-100%) LV1

This value determines the firing rate of the lead (master) boiler at which the first and all subsequent slave(s) (lag) boilers come on. The slave(s) (lag) boiler(s) will be delayed in coming on by the time set in **Option parameter 24.7**. At this point, the lead (master) and the will begin to modulate in unison. If the lead (master) and modulate above this point, the next as determined by priority number (**Option 24.1, 24.2, 24.3**) will be turned on. When more than one boiler is on, the master and last slave will modulate in unison while the other slaves are held at high fire.

5.6 Option 24.7 – lag (slave) On Delay (0-999 minutes) LV1

This option sets the time delay between the modulation rate of the lead (master) boiler (and last boiler on if any) exceeding the value set in **Option 24.6** and the next being turned on.

5.7 Option 24.8 – lag (slave) Off Rate (0-100%) LV3

When the lead (master) boiler and last boiler modulate below this modulation rate and exceed the value set in **Option 24.9**, the last turned on will be turned off. At this point, the lead (master) and the previous (if any) turned on will begin to modulate in unison until they together are below this setting. This will continue until only the lead (master) boiler remains on.

5.8 Option 24.9 – lag (slave) Off Delay (0-999 minutes) LV3

This option sets the time delay between the modulation rate is at or below the value set in **Option 24.8** and the last turned on being turned off. This also sets the time delay between successive slaves (lag) being turned off should the modulation rate stay below the setting in **Option 24.8**.

5.9 Option 25.0 – Banking based on temperature LV3

This option sets which input will be used and the 4-20mA current input from the temperature sensor must be connected into one of the 5 possible current inputs:

0 = lag banking on temperature is not enabled.

NOTE: Inputs 1 through 4 and remote tracking are externally powered. See NOTE below for use with loop-powered sensor.

1 = uses analog input 1. PA7(+) PA11(-).

2 = uses analog input 2. PA8(+) PA11(-).

3 = uses analog input 3. PA9(+) PA11(-).



4 = uses analog input 4. PA12(+) PA11(-). This input circuit needs an external 220-Ohm burden resistor.

5 = uses the remote tracking input as a 4-20mA input. PA15(+), PA14(-) and option 20.7 must be set to 0 and jumper JP2 must be set to the "IN" position (which sets the auxiliary input to be 4-20mA).

NOTE - If a loop-powered sensor is used, the "+" to the sensor is taken from PA16 for all inputs, and the "-" from the sensor to PA7, PA8, PA9, PA12 or PA15 depending on which input number is to be used. If the temperature sensor gives a current feedback that is out of range, i.e. Less than 3.5mA or greater than 21mA, lag banking on temperature will be cancelled and the sequence lag boiler will bank based on steam pressure.

The following option parameters are only visible if option 25.0 is non-zero:

5.10 Option 25.1 – Water temperature zero value LV3

Sets the zero value for the 4-20mA input (usually 0 for a 0-xxx degree temperature sensor).

5.11 Option 25.2 – Water temperature span value LV3

Sets the span value for the 4-20mA input (i.e. the sensor range xxx).

5.12 Option 25.3 – Water temperature cut-in LV1

Sets the low banking cut-in temperature.

5.13 Option 25.4 – Water temperature cut-out LV1

Sets the high banking cut-out temperature.

6 Resetting the Control

To reset the Nexus, the **MUTE/RESET** key will have to be pressed and held for one second to first silence (mute) the alarm and then a second press for three seconds to clear the fault. A prolonged key press will do both. (See Touchscreen Section 2.5) **NOTE:** The key changes from MUTE to RESET if an alarm has been silenced.

If for some reason the Nexus detects a fault, the cause of the fault will be displayed if still present. If not displayed, using the **ENGINEERS** tab will reveal the fault (see section 8.6).



7 Start-up sequence

When a fuel selection is made and the 'burner select' (PE6) signal is given to start up the burner, the control runs through the sequence described below. If a gas profile is selected, the control also performs safety valve pressure proving in parallel with the start-up sequence (see section 4.3 in Fireye Bulletin NEX-6101).

| Stage no. | Stage name | Description |
|-----------|----------------------------|---|
| 0. | Non-volatile lockout | The burner is held in this state until all faults are removed. |
| 1. | Burner off | The burner is checked to make sure that it has switched off completely. This includes main fuel safety valves closed, no flame signal and a 'no air pressure' signal. The control will remain in this state until there is a call for heat. |
| 2. | Wait for purge | The control waits for both a burner select and a fuel/air profile to be selected. Progression to stage 3 or 5 maybe held off by external influences, e.g. Communications control or digital input controlled by an external relay. E.g. building automation system |
| 3. | Open fuel valve | If gas and valve proving are selected, the gas motor is moved up for five seconds to allow any gas in the test section to be vented easily during the proving sequence. |
| 4. | Hold fuel valve | The fuel motor is held in position until step 1 of the safety valve proving sequence (open main valve 2, or vent valve) is completed. |
| 5. | Prove closed positions | If gas is selected, the gas valve proving sequence begins. The fuel and air motors are moved down until they stop. The final positions are compared with the closed positions stored in memory. |
| 6. | Prove air pressure | The burner motor is started and air pressure prove time t1 is initiated. The selected motors are moved up towards the purge position, unless the 'fan start early' option parameter has been set in which case the motors will not move until that time has expired. See Option Parameter 7.0. |
| 7. | Prove purge positions | When the air pressure prove time t1 has elapsed, the air pressure switch must give a 'pressure' signal or the control will lockout the burner. If primary air is selected both primary and secondary air signals must change from 'no pressure' to 'pressure' status. The selected motors are moved up until they stop. |
| 8. | Pre-purge | Once the servo-motors are at their purge positions the timed pre-purge t2 is initiated. |
| 9. | Move to ignition positions | When t2 has elapsed, the fuel and the air motors are moved to the ignition position for the selected profile. The control will wait for the gas valve proving sequence to finish if it is still in progress. |



| Stage no. | Stage name | Description |
|-----------|----------------------------|---|
| 10. | Pre-ignition | Once the fuel and air motors are at their ignition positions, the ignition transformer output is energized and pre-ignition time t3 is initiated. The ignition transformer <u>only</u> is on at this stage. |
| 11. | Pilot ignition | Once t3 has elapsed then: When firing on Gas, the pilot valve is energized and safety time t4 is initiated. Main Gas Valve 1 may also be energized if required and selected for pilot. When firing on Oil, the pilot valve is energized and safety time t4 is initiated. Main Oil valves may also be energized if Direct Ignition with Oil is selected. The ignition output may terminate at the end of t4 if Early Spark Termination is set by option 14.6. See Gas/Oil Start-up Timing Charts (following this table). |
| 12. | Pilot ignition interval | When the first safety time t4 has expired, a flame must be detected or the control will proceed to safety shutdown and lockout the burner. The ignition transformer may be ON or OFF as set by option 14.6. |
| 13. | Main ignition | Once the pilot interval time t5 has elapsed, the ignition transformer is turned off, the second (and first if not already open) main valve output(s) for gas or main oil valve output for oil is energized and the second safety time t6 is initiated. If firing on oil and ignition with main valve was selected the main oil valve will have already opened for pilot ignition. The ignition transformer may be ON or OFF as set by option 14.6. |
| 14. | Wait for flame established | When the second safety time t6 has expired, the pilot valve output is turned off. If permanent pilot is selected and the burner is firing on gas the pilot will remain open with the main valves. Main interval time t7 is initiated. This allows the main flame to stabilize before modulating. |
| 15. | Moving to low fire | When interval time t7 has elapsed, the flame is considered established and the fuel and air motors are moved from their ignition positions to their low fire positions. |
| 16. | Modulation | Once the fuel and air motors reach their low fire positions, they are modulated according to the demand placed on the burner. |
| 17. | Move to post-purge | If the fuel selection is changed or the 'burner on' signal is removed, the main valve output(s) are turned off. The fuel motor is moved to its closed position, and the selected motor(s) are moved to their purge position(s), if a post purge is selected and the post purge time is initiated. |
| 18. | Post-purge | When the post purge time has elapsed, the burner motor is turned off and the control returns to state 1 to wait for another startup. |



Faults and fault finding

8.1 The fault display

The NX6100 carries out a number of internal and external checks during operation. If a fault is found, a fault number (displayed with a text description) is used to identify the type of problem. A list of fault numbers may be found later in this chapter.

To view or review faults, use the MENU button, the FAULT/EVENT LOG button. (See Sections 2.9 and 2.11)

Many of the faults detected and displayed by the controller will cause a non-volatile lockout of the burner, that is to say that removing the power to the controller will not cancel a fault. Some other fault or limit messages will be displayed as a warning but operation of the burner will not be affected.

Each fault number is prefixed on the display by a letter as follows:

- F** This means that a fault has occurred and is still present.
The fault may be internal or external to the controller.
- C** This means that a fault did occur but has now cleared.
- L** This means a programmed limit has been exceeded.

For example :

```
217PSI Actual AUTO  
F10:Flame Failure
```

Many of the faults detected and displayed by the controller will cause a non-volatile lockout of the burner. Other faults will be displayed as a warning but operation of the burner will not be affected. A complete list of faults may be found later in this chapter.

Some fault information may be lost from the display if power is interrupted. However, the fault history in the display is retained by battery back up.

8.2 What to do when a fault occurs

If faults or limits are present and either the alarm or limit alarm/relay is on,(closed), then press the **MUTE RESET** key to mute the alarm (open the relay contacts). (See Touchscreen Section 2.9)

Take note of the fault message and use the Fault Listing to identify why the fault occurred.

If the faults, which cause a non-volatile lockout, are still present when the alarm is muted, then the alarm will operate again when the alarm clears, to indicate to the operator that the control burner may be restarted.

Once all faults have been diagnosed, rectified and cleared, press the **MUTE RESET** key for approximately three seconds to remove the fault messages and re-start the burner.

The function of the **MUTE RESET** key may also be achieved via Comview or by using the FAULT MUTE input. See option parameter 1.2 in Fireeye Bulletin NEX-6101.



8.3 Non-volatile lockout

If power is removed from the controller while a fault is still present, the fault will be stored in non-volatile memory. When power is restored to the controller, the fault number will still be present and it will be necessary to remove the fault before restarting the burner.

8.4 Fault subsets

As an aid to fault finding, most faults also have a *fault subset* that gives additional information about the type of fault or what the burner was doing when the fault occurred. Where applicable, the subsets are given in the fault listing in section 8.5. The fault subsets can be viewed using the engineer's key (see section 8.6).

8.5 Fault listing

| No | Cause | Description |
|-----|------------------------|--|
| F01 | External Alarm Fault 1 | One of the low voltage alarm / lockout inputs is causing an alarm. |
| F02 | External Alarm Fault 2 | The fault may be prefixed by either an 'L' or an 'F' and may or may not shutdown / lockout the burner. |
| F03 | External Alarm Fault 3 | See Option parameters 1918.1 to 1918.9. |
| F04 | External Alarm Fault 4 | <i>Subset : burner status.</i> |
| F05 | External Alarm Fault 5 | |
| F06 | External Alarm Fault 6 | |
| F07 | External Alarm Fault 7 | |
| F08 | External Alarm Fault 8 | |
| F09 | External Alarm Fault 9 | |



| No | Cause | Description |
|-----|--|---|
| F10 | Flame Failure | The flame detector did not register the presence of a flame when it should be present. <i>Subset : burner status</i> |
| F11 | False Flame | The flame detector registered the presence of a flame when it should not be present or when the shutter (if selected) was closed. <i>Subset : burner status</i> |
| F12 | External Alarm Fault from Input 12 | The high voltage alarm / lockout input number 12 is causing an alarm. The alarm number fault is may be prefixed by either an 'L' or an 'F' and may or may not shutdown / lockout the burner. See Option parameter 16.3. <i>Subset : burner status.</i> |
| F13 | External Alarm Fault from Input 13 | The high voltage alarm / lockout input number 13 is causing an alarm. The fault may be alarm number is prefixed by either an 'L' or an 'F' and may or may not shutdown / lockout the burner. See Option parameter 16.4. <i>Subset : burner status.</i> |
| F14 | Main (secondary) combustion air pressure not detected | The main (secondary) combustion air pressure switch failed to register air pressure when it should be present. <i>Subset : burner status</i> |
| F15 | Main (secondary) combustion air pressure detected when it should not be. Secondary air pressure. detected | The main (secondary) combustion air pressure switch registered air pressure when it should not be present (<i>subset : 1</i>), or the air pressure switch registered air pressure for more than 3 minutes after the burner was turned off (<i>subset : 2</i>). |
| F16 | Optional second P(primary) air pressure not detected | The primary air pressure switch failed to register air pressure when it should be present. <i>Subset : burner status</i> |



| No | Cause | Description |
|-----|---|---|
| F17 | Optional second (primary) air pressure detected when it should not be. Primary air pressure detected | The primary air pressure switch registered air pressure when it should not be present (<i>subset : 1</i>), or the air pressure switch registered air pressure for more than 3 minutes after the burner was turned off (<i>subset : 2</i>). |
| F18 | Not enough setpoints entered | A fuel/air ratio profile has been selected which does not have at least four setpoints commissioned. Use commission ratio mode to enter more setpoints. <i>Subset : fuel code</i> |
| F19 | Circuit board voltage reference fault | The circuit board has an incorrect on-board reference level. <ul style="list-style-type: none">• Ensure ALL analog inputs (4-20mA, 0 – 5Vv) are in the range 0 to 5Vdc. It is critical to the controller operation that none of the inputs are higher than 5V.0 volts.• If the problem persists even when all analog inputs are disconnected, check EK37 and contact supplier. <i>Subset : +1 out of range, +2 zero check failed, +4 span check failed.</i> |



| No | Cause | Description |
|-----|----------------------------|--|
| F20 | Drive 0 position fault | A drive-positioning fault has occurred, which will cause a non-volatile lockout of the burner. This fault has occurred for one of the following reasons: |
| F21 | Drive 1 position fault | 1. During 'Close' position prove, the measured position when a drive stops at a position that is outside the commissioned 'Close' set position, by more than five degrees. |
| F22 | Drive 2 position fault | 2. During Purge position prove, the measured position is in error, to the commissioned 'Purge' position, by more than five degrees. |
| F23 | Drive 3 position fault | 3. when a drive stops at a position that is outside the purge set position by more than five degrees. |
| F24 | Drive 4 position fault | 4. During pre-purge, ignition or post-purge, when a drive moves from its setpoint. |
| F25 | Drive 5 position fault | 5. During modulation, when a drive is not at its correct setpoint as defined by the commissioned fuel/air ratio for the selected profile. |
| F26 | Drive 6 position fault | A servo drive is defined as having moved from its setpoint if its positional error is more than 1° for 15s, or more than 5° for 1s. For positional errors between 1° and 5°, the detection time is variable between 15s and 1s. |
| F27 | Drive 7 position fault | Inverter (VSD) drive error bands variable and set in option parameter 09.1. |
| F28 | Drive 8 position fault | Note : Only the selected drives (i.e. used on the current fuel/air profile) drives are checked. The other drives are ignored. |
| F29 | Drive 9 position fault | <p><i>Subset : burner status.</i></p> <p>000 – 016 = Burner Status</p> <p>032 – 048 = CAN communications error. Display shows ERR1 under drive name</p> <p>>064 = Internal servo fault. Display shows ERR2 – ERR7 under drive name</p> |
| F30 | Gas Proof of Closure fault | <p>The gas (main 2) valve proof of closure signal is not responding correctly. The fuel valve "proof of closure" switch must change state (e.g. open or close) within 7 seconds of the valve being energized or de energized.</p> <p><i>Subset : burner status.</i></p> |



| No | Cause | Description |
|-----|----------------------------|--|
| F31 | Oil Proof of Closure fault | <p>The oil valve proof of closure signal is not responding correctly. The fuel valve “proof of closure” switch must change state (e.g. open or close) within 7 seconds of the valve being energized or de energized.</p> <p><i>Subset : burner status.</i></p> |
| F32 | Safety input fault | <p>One or more of the fail-safe low voltage inputs is registering a fault. Check digital inputs 1 to 8 are wired to the correct commons.</p> <p><i>Subset : Combination of failed inputs, (binary coded).</i></p> |
| F33 | Burner input fault | <p>One or more of the fail-safe high voltage inputs is registering a fault.</p> <p><i>Subset : Failure model input number.</i></p> |
| F34 | Primary relay fault | <p>One or more of the internal relays is not responding correctly.</p> <p><i>Subset : Failed Relay.</i></p> |
| F35 | ADC fault | <p>One of the internal checks on the analog to digital converter has failed.</p> <p><i>Subset : Failure mode.</i></p> |
| F37 | RAM test fault | <p>The main memory in the controller has malfunctioned.</p> <ul style="list-style-type: none">• Interrupt power to the controller.• This could be due to high levels of electrical interference getting into the product. Check all cables are correctly screened, and screens are terminated correctly. Ensure the mains supply is not excessively noisy.• If this fault persists, the controller must be returned to the supplier. <p><i>Subset : Failed Page.</i></p> |



| No | Cause | Description |
|-----|------------------------------|---|
| F38 | Program memory CRC fault | <p>The program memory in the controller has been corrupted.</p> <ul style="list-style-type: none"> • Interrupt power to the controller • This could be due to high levels of electrical interference getting into the product. Check all cables are correctly screened, and screens are terminated correctly. Ensure the mains supply is not excessively noisy. • If this fault persists, the controller must be returned to the supplier. <p><i>Subset : Failed Page.</i></p> |
| F39 | Profile table CRC fault | <p>The profile table memory in the controller has been corrupted.</p> <ul style="list-style-type: none"> • Interrupt power to the controller. • Erase the system using option parameter 45.1 = 5 and re commission (or restore with option parameter 45.2). • This could be due to high levels of electrical interference getting into the product. Check all cables are correctly screened, and screens are terminated correctly. Ensure the mains supply is not excessively noisy. • If this fault persists, the controller must be returned to the supplier. <p><i>Subset : Failed Page.</i></p> |
| F40 | Single fuel only fault | <p>This fault will appear if a an attempt is made to commission an oil profile on a gas only unit, or a gas profile on an oil only unit. Check option parameters 6.1 to 6.4</p> |
| F41 | Boiler safety limit exceeded | <p>The boiler's measured value has exceeded the pressure/temperature safety limit, or the Fireeye pressure/temperature sensor is not responding correctly.</p> <p><i>Subset :</i> 1 = - sensor feedback < 1V, 2 =- sensor feedback > 5V, 3 =- sensor failed during test, 4 =- safety limit exceeded</p> |
| F42 | Valve proving fault | <p>The measured gas pressure was not correct during the gas valve proving test.</p> <p><i>Subset: Valve prove status.</i></p> |



| No | Cause | Description |
|-----|---------------------------|---|
| F43 | Gas pressure limit | The measured gas pressure is outside the operating limits S(<i>subset : valve prove status</i>) , or 10 = the gas pressure sensor is not responding correctly (<i>subset : 10</i>). |
| F46 | EEPROM memory CRC fault | <p>The EEPROM memory in the controller has been corrupted. This memory is used to store the option parameters,</p> <ul style="list-style-type: none"> • Interrupt power to the controller • Erase the system using option parameter 45.1 = 5 and re commission (or restore with option parameter 45.2). • This could be due to high levels of electrical interference getting into the product. Check all cables are correctly screened, and screens are terminated correctly. Ensure the mains supply is not excessively noisy. • If this fault persists, the controller must be returned to the supplier. <p><i>Subset : Failed Page.</i></p> |
| F50 | Oxygen probe heater fault | <p>The probe heater has failed to heat to the correct temperature after 30 minutes of system power up.</p> <ul style="list-style-type: none"> • Is the probe heater wiring correct? • Is the probe cell thermocouple wiring correct? <p>Once the fault is rectified, it will be necessary to interrupt the power to the oxygen probe interface to make it attempt to heat the probe once more.</p> <p><i>Subset: O2 probe status.</i></p> |
| L52 | Oxygen low limit alarm | <p>The oxygen level measured value is below the oxygen setpoint low alarm value for the current profile.</p> <p><i>Subset: 0 = Limit violation, 1 = Probe Failed.</i></p> |
| L53 | Oxygen high limit alarm | <p>The oxygen level measured value has exceeded the oxygen setpoint high alarm value for the current profile.</p> <p><i>Subset: 0 = Limit violation, 1 = Probe Failed.</i></p> |



| No | Cause | Description |
|-----|--|---|
| F54 | Oxygen probes mismatch fault | <p>This fault occurs when two oxygen probes are used to give fail-safe oxygen monitoring. If this fault occurs, check and calibrate both oxygen probes. It may be necessary to increase option parameter 42.4 or 42.5 (within safe limits) if the oxygen probes are in different parts of the flue.</p> <p>Subset :</p> <p>1 = Oxygen values do not match, 2 = Flue temperatures do not match 3 = Neither the flue temperature and/or oxygen levels do not match 4 = Second oxygen probe is faulty/not ready. See EK 76.</p> |
| L55 | Trim limit alarm | <p>The trim drive has reached the allowed maximum deviation limit.</p> <ul style="list-style-type: none"> • Change trim limit. • Re-commission fuel / air ratio. <p>Subset : <i>Not applicable.</i></p> |
| F57 | Auto trim commissioning fault | <p>The measured oxygen level exceeded 15.0% during auto trim commissioning. The burner is shutdown.</p> <p>Subset : <i>Last auto trim commission setpoint (+32 if adding air).</i></p> |
| L58 | Flue temperature low alarm value exceeded | <p>The measured flue temperature is below the low alarm value for the current profile, or the flue thermocouple is faulty.</p> <p>Subset : <i>Not applicable.</i></p> |
| L59 | Flue temperature high alarm value exceeded | <p>The measured flue temperature has exceeded the high alarm value for the current profile.</p> <p>Subset : <i>Not applicable.</i></p> |
| F63 | Option parameters uploaded | <p>The option parameters have been uploaded via serial communications. Check all values are correct and match the application, then set option parameter 45.0 to 0.</p> |



| No | Cause | Description |
|-----|------------------|--|
| F64 | Profile Invalid | <p>This fault means that the controller can't fire the currently selected profile because it isn't sure it still matches the burner / site configuration. It could lead to a hazardous situation.</p> <p>There are three possible causes to this fault :</p> <p>1 – A drive has been commissioned in this profile but has now been deselected. E.g. - If a profile is commissioned with two air dampers but then the second air damper is de-selected with option parameter 4.0 to 4.9, then obviously the profile is no longer valid.</p> <p><i>Subset : Drive number (0 to 9)</i></p> <p>2 – Servo / Drive changed. If the system is commissioned then later one of the servos is changed for a new one (i.e. different serial number), any profiles that use the original at servo are now considered invalid. (This is to ensure that the maintenance engineer checks that the new servo is mechanically fixed the same way as the original one.)</p> <p><i>Subset : Invalid profile + 100 (101 to 104).</i></p> <p>3 – The selected profile has been uploaded from a PC, but has not been verified on this burner.</p> <p><i>Subset : Invalid profile + 100 (101 to 104).</i></p> <p>In all cases the F64 can be cleared by switching to another (valid/good) profile, or by re-commissioning the profile in 'commission ratio' mode, making sure all points up to and including high fire are acknowledged using the 'NEXT' key (or 'ENTER' if the points are adjusted).</p> |
| F65 | Power-up Lockout | <p>The controller has locked out on power-up. This will normally be because option parameter 1.0 is set to 1.</p> <p><i>Subset :</i></p> <p><i>0 – See option parameter 1.0.</i></p> <p><i>254 – Serial EEPROM write failure.</i></p> <p><i>255 – NV Lockout verification failed.</i></p> |
| F66 | Flame Test | <p>The flame test (dark test) has failed. This could be a problem with the flame input circuitry, or a shutter problem / failed UV tube if a shuttered UV is used.</p> <p><i>Subset : burner status.</i></p> |



| No | Cause | Description |
|-----------|---|--|
| F67 | Secondary relay fault | <p>A secondary fault has occurred with the main 1, main 2, pilot, vent or non-volatile lockout relays. Tests are performed once an hour. If two consecutive tests fail then the controller will Lockout and display the fault number.</p> <ul style="list-style-type: none">• Contact supplier <p><i>Subset : Failed relay number.</i></p> |
| F68 | Secondary program memory checksum fault | <p>A fault has occurred with the program memory in the controller. Tests are performed once an hour. If two consecutive tests fail then the controller will Lockout and display the fault number.</p> <ul style="list-style-type: none">• Contact supplier <p><i>Subset : Not applicable.</i></p> |
| F69 | Secondary watchdog fault | <p>A fault has occurred with the CPU watchdog. Tests are performed once an hour. If two consecutive tests fail then the controller will Lockout and display the fault number.</p> <ul style="list-style-type: none">• Contact supplier <p><i>Subset :</i> <i>1 = Late test failed.</i> <i>2 = Early test failed.</i></p> |
| F70 – F79 | User Faults | <p>These fault numbers are generated by the user programmable section of the controller and will vary with the application.</p> |

8.6 The engineer's tab

By selecting the engineer's tab it is possible to read the values of internal system variables and external input and output states. It is also possible to see the values of *fault subsets*, in order to obtain more detailed information about a fault that has occurred.

When using the engineer's tab it is not possible to change any parameters. Therefore, it is not possible to affect the operation of the burner.

After pressing the **MENU** button, press **BURNER SETTING** button, then the Engineers Values tab. (See Touchscreen Section 2.9)

8.7 System Event/Fault history.

The NX6100 stores information on events and faults. The memory in the unit will store the last 128 events/faults, and associated status data and, as an option, a date and time stamp. The 100 most recent events/faults are available via the display unit and all 128 are available through Comfire 2.

8.8 Engineer's key parameter list

| No. | Name | Description |
|-----|--|--|
| EK1 | Low Voltage Digital Input 1 PB9 – PB10 | Shows the state of each input. Where : 0 = OFF 1 = ON |
| EK2 | Low Voltage Digital Input 2 PB9 – PB11 | |
| EK3 | Low Voltage Digital Input 3 PB9 – PB12 | |
| EK4 | Low Voltage Digital Input 4 PB9 – PB13 | |
| EK5 | Low Voltage Digital Input 5 PB14 – PB15 | |
| EK6 | Low Voltage Digital Input 6 PB14 – PB16 | |
| EK7 | Low Voltage Digital Input 7 PB14 – PB17 | |
| EK8 | Digital Input 8 / Profile 1 | |
| EK9 | Digital Input 9 / Profile 3 | |



| No. | Name | Description |
|------|--|--|
| EK10 | Profile 2 (PB8 – PB6) | |
| EK11 | Profile 4 (PB8 – PB7) | |
| EK12 | Profile 3 Select (Low Voltage) High voltage digital input 12. PE4 | |
| EK13 | High voltage digital input 13. PE5 | |
| EK14 | Burner Select Input (High Voltage) PE6 | |
| EK15 | Airflow Input (Low Voltage) PB18– PB19 | |
| EK16 | Warming limit | <p>0 - Measured value above warming limit, burner free to modulate.</p> <p>1 - Measured value below warming limit, burner held at low fire if the controller is in auto or sequencing mode.</p> |
| EK17 | Flame Detected | <p>0 – No flame detected.</p> <p>1 – Flame detected.</p> <p>When both flame inputs are used together, this value will only show '1' when both inputs are above their flame threshold.</p> |
| EK18 | Boiler status | <p>0 - Burner will not fire because the temperature / pressure measured value has exceeded the high controller value.</p> <p>1 - Burner will fire because the temperature / pressure measured value has fallen below the low controller value.</p> |
| EK19 | Confirm to adjust | <p>0 - Controller not in commission mode or control is in commission mode and drives moving to setpoints.</p> <p>1 - Controller in commission mode and drives may be adjusted using the UP/DOWN keys.</p> |



| No. | Name | Description |
|------|------------------------------|---|
| EK20 | Drive moved | <p>0 - Controller not in commission mode or control is in commission mode and drives have not been moved using the UP/DOWN keys.</p> <p>1 - Controller in commission mode and drives have been moved using the UP/DOWN keys.</p> |
| EK21 | Positions proved | <p>0 - Drives have stopped moving, ready for position prove test.</p> <p>1 - Ready for position prove test but drives still moving.</p> |
| EK22 | Fault alarm | <p>0 – No un-muted alarms (faults) present.</p> <p>+1 - Un-muted fault alarm present (prefix : F)</p> <p>+2 - Un-muted limit alarm present (prefix : L)</p> <p>+4 – Un-muted flue-monitoring alarm present (faults 50 to 59).</p> |
| EK23 | Oxygen Trim Enable | <p>0 – Oxygen trim off or not working.</p> <p>1 – Oxygen trim on and working.</p> |
| EK24 | Oil warming Active | The burner will not fire because the oil is not up to temperature and the oil warming function is active. |
| EK25 | CAN_TX Failures | A count of the number of times the can bus controller has failed to send a message since power-up. This should be zero unless there has been a problem. |
| EK26 | Commission status | <p>Current commissioning mode, where :</p> <p>0 - Normal run mode.</p> <p>1 - Adjust ratio mode.</p> <p>2 - Commission ratio mode.</p> |
| EK27 | Commission setpoint | <p>The current setpoint being commissioned.</p> <p>0 - Closed setpoint.</p> <p>1 - Purge setpoint.</p> <p>2 - Ignition setpoint.</p> <p>3 - Low fire setpoint.</p> <p>4 - 24 - profile setpoints</p> |
| EK28 | Commission Setpoints entered | The number of setpoints that have been successfully entered during this commission ratio session. |



| No. | Name | Description |
|------|------------------------------------|---|
| EK29 | Modulation rate (%) | The current modulation rate of the burner. 0 = Low Fire 100 = High fire |
| EK30 | Burner Status | Status of the start-up sequence. See section 7. |
| EK31 | Fuel Profile Selected | The currently selected fuel profile. |
| EK32 | Number of commission setpoints | The number of setpoints entered in the current commission ratio session : 0 - No setpoints entered. 1 - Close setpoint only. 2 - Close and purge setpoints. 3 - Close, purge and ignition. 4 - 24 - profile setpoints. |
| EK33 | Modulation mode | The current modulation mode : 0 - Auto mode. 1 - Manual from external input. 2 - Manual from keyboard. 3 - Boiler sequencing controller. 4 - Low fire hold. |
| EK34 | Photocell / IR sensor signal value | Signal value received from the flame sensor input. For the photocell / IR input : 0 - Fully dark. 999 - Fully light. |
| EK35 | UV sensor signal value | Signal value received from the flame sensor input. 0 - No flame detected. 999 - Flame detected. |
| EK36 | Nearest setpoint | The number of the profile setpoint which setpoint that is nearest to the current modulation position. |
| EK37 | Voltage reference error (V) | The error between the measured voltage reference and the calibrated value. |
| EK38 | Boiler Sequencing Status | Currently unused. |
| EK39 | Fuel Swap Status | Currently unused.If non zero, the controller is in the process of performing a fuel profile swap (without turning the burner off). |
| EK40 | Shutdown setpoint | The nearest setpoint (EK36) when the burner last locked out. |



| No. | Name | Description |
|------|--|---|
| EK42 | Adjust ratio counter | The number of times adjust ratio mode has been used. |
| EK43 | Commission ratio counter | The number of times commission ratio mode has been used. |
| EK44 | Oxygen measured value | The current flue oxygen value as measured by the Fireeye probe (if fitted). |
| EK45 | Oxygen probe status | +1 - Internal fault. +2 - Internal fault. +4 - Heater fault. Causes F50. +8 - Cell temperature out of range. +16 - Cell millivolts out of range. +32 - Can bus error. +64 - Probe calibrating in reference gas. See option parameter 30.6. +128 - Probe calibrating in air. See option parameter 30.6. |
| EK46 | Oxygen trim status Note: The values to the right are binary. If the value of EK46 is not specifically listed to the right: first, subtract the highest value you can, and then from the remainder, subtract the next highest value you can, and so on. Each value is a potential reason why the trim is not working. See example below. | 0 - O ₂ trim working, or +1 – no oxygen interface connected. +2 – no oxygen probe serial number entered, or , option 30.5 not 1, or , option 30.8 not 0 or , no trim type selected by option 31.x, trim not selected via aux input or , trim not selected via dig i/p, serial comms +4 – O ₂ setpoints or flow values incorrect +8 - Option 20.6 not 0 +16- Not modulating +32- In commission mode +64- Probe faulty (see EK45) |



| No. | Name | Description |
|------|---|---|
| | | <p>Example: If EK46 = 70, for possible reasons why the trim is not working:</p> <p>The highest description number that can be subtracted from 70 is 64, so the first possible reason is +64 - "Probe faulty" (noted above)</p> <p>Since 70-64=6 there could be an additional reason. Since the highest description number that can be subtracted from 6 is 4, the second possible reason is +4 - "O₂ setpoints or flow values incorrect" (noted above)</p> <p>Since 70-64-6=2 there could still be an additional reason. The highest description number that can now be subtracted from 2 is 2, so the third possible reason is +2 - "(entire +2 description noted above)"</p> |
| EK47 | Oxygen setpoint (%) | Current oxygen setpoint. This is only available if trim is enabled and working. |
| EK48 | Excess air (%) | Excess combustion air at the current firing position. |
| EK49 | Oxygen error (%) | Error between O ₂ measured value and O ₂ setpoint. |
| EK50 | Trim deviation (% flow) | Deviation in air flow/airflow imposed by trim (-25 to +25%) |
| EK51 | Gas pressure (mBar display units) | Measured gas pressure from the gas pressure sensor (sensor must be enabled and gas must be selected). |
| EK52 | VPS Valve close time t_{test} (s) | Time for which each half of the valve prove test will be conducted, This time counts down to zero during stages 2 and 4 of the valve prove test. |
| EK53 | Gas pressure change (P_{test} display units) | Maximum Pressure drop/rise limit allowed during the valve prove test. |
| EK54 | Valve prove status | Status of valve proving sequence. |
| EK55 | Main PCB issue | The issue number of the main circuit board that the firmware is expecting. This may be different to the actual PCB issue if they are compatible. |
| EK56 | Software issue. | The current revision of the main product firmware. |
| EK57 | Spare | N/A |



| No. | Name | Description |
|--------------|---|--|
| EK57EK 58 | CPU serial number (low 4 digits)CPU serial number (high 3 digits) | The 6 digit CPU board serial number. The serial number is displayed in 2 blocks of 3 digits. |
| EK59 | Drives at setpoint | Represents which drives are currently at their setpoints, where: 0 – All drives are at their setpoints and are not moving. Non- zero – One or more drives are not at their setpoint. |
| EK60 | Digital (relay) outputs on. | The combination of digital outputs currently switched on. +1 : Digital Output 1 ON. Display, PR3(COM), PR1(NO), PR2(NC). Low voltage or line voltage. +2 : Digital Output 2 ON. Display, PR3(COM), PR5(NO), PR4(NC). Low voltage or line voltage. +4 : Digital Output 3 ON. Display, PR7(COM), PR9(NO), PR8(NC). Low voltage or line voltage. +8 : Digital Output 4 ON. Main Unit, PD6(COM), PD7(NO), PD8(NC). Low voltage or line voltage. +16 : Digital Output 5 ON. Main Unit, PD6(COM), PD4(NO), PD5(NC). Low voltage or line voltage. +32 : Digital Output 6 ON. Main Unit, PD1(COM), PD2(NO), PD3(NC). Low voltage or line voltage. +64 : Digital Output 7 ON. Daughterboard, PZ15 – PZ16. LOW VOLTAGE AND CURRENT ONLY. +128 : Digital Output 8 ON. Daughterboard, PZ17 – PZ17. LOW VOLTAGE AND CURRENT ONLY. |
| EK61 | Analog Input 1. Main Unit Terminal PA7. | The raw ADC counts from analog input 1. 0 to 1023 for 0 to 5.00 volts. 4mA = 180 counts 20mA = 900 counts |



| No. | Name | Description |
|------|--|---|
| EK62 | Analog Input 2. Main Unit Terminal PA8. | The raw ADC counts from analog input 2. 0 to 1023 for 0 to 5.00 volts. 4mA = 180 counts 20mA = 900 counts |
| EK63 | Analog Input 3. Main Unit Terminal PA9. | The raw ADC counts from analog input 3. 0 to 1023 for 0 to 5.00 volts. 4mA = 180 counts 20mA = 900 counts |
| EK64 | Analog Input 4. Main Unit Terminal PA12 (also gas pressure). | The raw ADC counts from analog input 4. 0 to 1023 for 0 to 5.00 volts. 4mA = 180 counts 20mA = 900 counts |
| EK65 | Analog Input 5. Main Unit Terminal PA15 (also remote setpoint). | The raw ADC counts from analog input 5. 0 to 1023 for 0 to 5.00 volts. 4mA = 180 counts 20mA = 900 counts |
| EK66 | Analog Input 6. Main Unit Terminal PA19 (also boiler measured value). | The raw ADC counts from analog input 6. 0 to 1023 for 0 to 5.00 volts. 4mA = 180 counts 20mA = 900 counts |
| EK67 | Analog input 7. Daughterboard terminal PZ12(-) PZ13(+). Also VSD1. | The ADC counts from analog input 7. 0 to 999 for 4 to 20mA. |
| EK68 | Analog input 8. Daughterboard terminal PZ13(-) PZ14(+). Also VSD2. | The ADC counts from analog input 8. 0 to 999 for 4 to 20mA. |
| EK69 | Daughter board Frequency input 1 (PZ7). 0 to 12 volts. | Gives the measured frequency in Hz on this input. If the input is not changing, this value will be 0 for OFF (open circuit) and 1 for ON. |
| EK70 | Daughter board Frequency input 2 (PZ9). 0 to 12 volts. | Gives the measured frequency in Hz on this input. If the input is not changing, this value will be 0 for OFF (open circuit) and 1 for ON. |
| EK71 | Daughter board Frequency input 3 (PZ11). 0 to 12 volts. | Gives the measured frequency in Hz on this input. If the input is not changing, this value will be 0 for OFF (open circuit) and 1 for ON. |



| No. | Name | Description |
|---------------|---|--|
| EK72 | Oxygen probe cell temperature. | The temperature of the zirconia cell inside the Fireeye oxygen probe, if fitted. This value should be very close to 650°C for accurate operation. |
| EK73 | Ambient air temperature. | The temperature measured by the inlet temperature sensor, if fitted. Units are °C. |
| EK74 | CPU utilization (%). | The percentage utilization of the CPU. Should be less than 95% at all times. |
| EK75 | Second O2 level (%) Longest task time. | The measured flue oxygen level as measured by the second oxygen probe interface.(%)The current longest internal software task time. This is provided for manufacturers diagnostics only and may be removed in future versions. |
| EK76 | Second probe status Longest task number. | The same as EK45, but for the second oxygen probe. The current longest internal software task number. This is provided for manufacturers diagnostics only and may be removed in future versions. |
| EK77 | Last program byte address Program size. | This is the length of the currently running user / manufacturers program. If a user program is selected, this should match the program length given by the 'abacus' software. |
| EK78 | Second cell temp (°C) | The internal zirconia cell temperature of the second oxygen probe, if fitted. |
| EK79 | Second flue temp (°C) | The flue temperature, as measured by the second oxygen probe, if fitted. |
| EK80 - 89 | Drive Error values for drives 0 to 9. | The current error value for drives 0 to 9. These values will freeze when the controller performs a safety shutdown, so it may be possible to look at these values after a lockout to help determine the cause. |
| EK90 | Burner cycles | The number of times the burner has attempted to start. |
| EK91 | Burner Lockouts | The number of times the burner has locked out. |
| EK92- Ek99 | Spare | N/A |

| No. | Name | Description |
|-------|---------------------------|---|
| EK100 | Firmware type PT22xxxx... | This shows the last four digits of the firmware part number for the NX6100 firmware. It is used for product variant identification. |



- The product allows for customization of various non-safety critical functions including the modulation control. The engineers' keys shown below relate to the default modulation control function programmed in the control at the factory. To verify this has not been replaced by an application specific function check with the equipment supplier and / or check option parameter 00.4, if available.

| No. | Name | Description |
|-------|------------------------|--|
| EK101 | PID1 Active | If the value is 1, Setpoint / PID set 1 is active. |
| EK102 | PID2 Active | If the value is 1, Setpoint / PID set 2 is active. |
| EK103 | Control Limits Active | If the value is 1, the control limits are active and will turn the burner on and off as the load dictates. The low and high limits are shown on EK153 and 154. If the control limits are holding the burner off, EK18 will be zero. |
| EK104 | User modulation mode | This will normally be zero. A custom modulation program may change this value if it is modifying the modulation rate. |
| EK105 | PID not required | If this value is 1, the internal modulation PID is not running. This may be because the burner is off, in commission / manual mode or for another reason. |
| EK106 | Burner Firing | If this value is 1, the burner is firing (fuel valves open), or it is in post-purge. |
| EK107 | Warming Limit Active | If this value is 1, the warming limit function (see option parameter 23.0) is holding the burner at low fire (status 15). |
| EK108 | Remote Tracking Active | If this value is 1, the remote tracking function is active. See option parameter 20.7. The AUTO modulation rate will come from analog input 5. |



| No. | Name | Description |
|-----------------|--|---|
| EK109 | Remote Setpoint 1 Active | If this value is 1, the remote setpoint 1 function is active. See option parameter 20.7. The value of Setpoint 1 will come from analog input 5. |
| EK110 to EK119 | Not used by the standard manufacturers program. May be used by a custom program. | N/A |
| EK120 | Lead selected | Controller has a command to be Lead |
| EK121 | Running as lead | Controller has control of the sequence system |
| EK122 | 1st Slave ON | 1st Slave is required ON |
| EK123 | 2 nd Slave ON | 2 nd Slave is required ON |
| EK124 | 3 rd Slave ON | 3 rd Slave is required ON |
| EK125 | New Lead asserted | A new lead has been selected |
| EK126 | Lead in Prop band | Lead is modulating to the load in the proportional band |
| EK127 | Burner available | 1 = Burner available for sequencing |
| EK128 | 2 Slaves | 1 = 2 slaves available |
| EK129 | 3 Slaves | 1 = 3 slaves available |
| EK130 | Don't control SL1 | 1 = Slave 1 will not be used |
| EK131 | Don't control SL2 | 1 = Slave 2 will not be used |
| EK132 | Don't control SL3 | 1 = Slave 3 will not be used |
| EK133 to EK150. | Not used by the standard manufacturers program. May be used by a custom program. | N/A |
| EK151 | Setpoint 1 control value | The actual value of setpoint 1 being applied. |
| EK152 | Setpoint 2 control value | The actual value of setpoint 2 being applied. |
| EK153 | Low control limit | The actual value of the low control limit (cut-in point) being applied. |
| EK154 | High control limit | The actual value of the High control limit (cut-out point) being applied. |
| EK155 | Spare | N/A |
| EK156 | Measured Value | The current boiler measured value (actual value) shown with increased precision. |



| No. | Name | Description |
|-----------------|--|---|
| EK157 | AUTO modulation rate | The modulation rate that the boiler will fire to if in AUTO mode (providing option parameter 15.0 is not zero or 1). |
| EK158 | Sequence status | 0= Not available for sequence +1= Available for sequencing +2= New Lead selected +4= Running as Lead +8= Firing from setpoint 1 +16= Burner status < 8 |
| EK159 to EK199. | Not used by the standard manufacturers program. May be used by a custom program. | N/A |
| EK200 | Prog: | Currently running manufacturers / custom (user) modulation program name and revision number (if applicable). |

9 Troubleshooting

9.1 Display / General

| Problem | Possible cause | Suggested action |
|--|--|--|
| Display shows it's serial number but not data from controller unit | Display CAN bus wired incorrectly. Main controller not running. | Check wiring of CAN bus (PT3 and PT4). Check main controller low voltage electronics fuse FS2. If blown, investigate all low voltage external wiring and replace fuse, if necessary, with a new one of the correct type and rating. |
| Display updates slowly or seems to freeze when scrolling a parameter number. | One of the CAN devices has the two CAN wires crossed over. | Check wiring of the can cable. |
| Display will not light at all. | 24VAC supply to display missing. Main controller not running. | Check for 24VAC on PT1 and PT2. Check fuse FS1. If blown, investigate all high and low voltage external wiring and replace fuse, if necessary, with a new one of the correct type and rating. |
| Measured value incorrect. | Wrong sensor voltage. Wrong sensor input type. Incorrect sensor wiring. Wrong zero or span. | Check SENS SUPP link (see Error! Reference source not found.) Check SENS IN link (see Error! Reference source not found.) Check wiring to terminals PA18 to PA20.. Check option parameters 15.0, 15.1, 15.2. |
| Hours run shows '---'. | No profile selected. | Select oil or gas profile. |
| Modulation rate is 0. | Burner not modulating. | Wait for burner to finish start-up sequence. |



| Problem | Possible cause | Suggested action |
|----------------------------|--|---|
| Burner status is flashing. | Controller in non-volatile lockout mode. | Burner status before shutdown displayed. |
| Gas pressure not shown. | Gas sensor not selected. | Select sensor using option parameter 10.0 |
| Gas pressure incorrect. | Incorrect span value. | Check option parameter 10.1 |

9.2 Startup

| Problem | Possible cause | Suggested action |
|---|--|---|
| Burner will not start. | Controller in non-volatile lockout. High control limit exceeded. Control in commission ratio mode. Burner off via serial comms. Air pressure switch still made. No fuel selected. Burner not selected. | Hold FAULT MUTE key when faults clear. Check EK18 and wait for press/temp to drop. Press NEXT to advance to next setpoint. Turn the burner ON using Comview software (if fitted), or Profibus / Modbus interface. Use section 7 and burner status (EK30) to define what the controller is waiting for. Also check EK31≠0, EK10=1, EK15=0. |
| Drive positioning fault occurs before drives move to purge. | Stored close positions do not match actual close positions. | Check feedback potentiometers and motor micro-switches. Reset close positions using commission ratio mode. |
| Drive positioning fault occurs when drives reach purge. | Stored purge positions cannot be reached. | Check feedback potentiometers and motor micro-switches. Reset purge positions using commission ratio mode. |
| Drives stuck at ignition and burner has not fired. | Drives cannot reach ignition position. | Check motor micro-switches and linkages. |
| Pilot, main 1 and main 2 valves will not open. | No feed on BURNER SEL. | Check terminal PE6. |
| Drives stuck at ignition and burner has fired. | Ignition time has not elapsed. | Wait for ignition time to elapse. Reduce ignition time (option parameter 04.1). |

9.3 Commissioning

| Problem | Possible cause | Suggested action |
|--|--|--|
| Cannot get past P0. | See 'burner will not start' above. | See 'burner will not start' above. |
| 'Px' or 'Ax' display flashes constantly and motor positions cannot be altered. | Drives are moving to position. Burner off in adjust ratio mode. A0, A1, A2 displayed. Valve proving test in progress. | Wait for drives to position. Turn burner on if you need to adjust points Aa3 onwards. Wait for valve proving test to finish. |
| Option parameter not available. | Another option parameter must be set first. | Set option parameter (usually XX.0) to a non-zero value to enable other param's in group. |
| Option parameter not | Wrong passcode entered or | Enter the supplier passcode and/or turn the |



| Problem | Possible cause | Suggested action |
|--|--|---|
| adjustable. | burner firing. | burner off before changing the value. |
| Not possible to enter commission ratio mode. | Supplier passcode incorrect. Burner firing (goes into adjust ratio mode). | Enter correct passcode. Turn burner off and try again. |
| Not possible to enter adjust ratio mode. | Supplier passcode incorrect. | Enter supplier passcode with the burner on. |

9.4 Gas valve proving

| Problem | Possible cause | Suggested action |
|---|--|---|
| Proving sequence takes a long time. | Nominal gas pressure, test volume or leakage rate wrong. | Check option parameters 10.1 to 10.7. Expected time shown on EK52. |
| Main valve 2 does not open. | Vent valve has been selected. | Check option parameter 10.7. |
| Vent valve does not open. | Vent valve not selected. | Check option parameter 10.7. |
| Main valve 1 and/or main valve 2 do not open. | Valve proving not selected. No feed on BURNER SEL. | Check option parameter 10.0. Check for feed on terminal PE6. |

9.5 Modulation

| Problem | Possible cause | Suggested action |
|--|---|--|
| Sensor or modulation rate inaccurate. | V/I input setting incorrect. 5/30V supply setting incorrect. | Check option parameter. Check SENSOR IN and SUPPLY links. |
| Intermittent positioning faults. | Profile setpoint is too close to the P0 micro-switch position. Poor Earth or screening. Feedback potentiometer faulty. Communication to servo motor(s). | Move the increase the setpoint end points further away from the P0 position high/low. Check wiring. Move motor across range and check the feedback in commission ratio mode with the burner off. Check wiring. |
| Controller stuck at low fire. | Meas. value exceeds setpoint. Warming limit active Controller in MANUAL mode. External low fire hold, or missing AUTO input from burner controller. In manual mode. | No fault. Wait for boiler to warm up. Check EK16. Press the AUTO key to change to auto mode Remove feed from Aux inputs (if selected). Check EK 6. Increase the mod. rate using 'UP' key. Check PID, proportional band must be greater than zero to modulate |
| Controller stuck at a modulation rate. | Serial communications. Controller in commission mode. | Disable or change modulation slider in Computer software. Press RUN then ENTER to enter run mode. |

9.6 Inverters

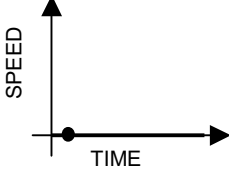
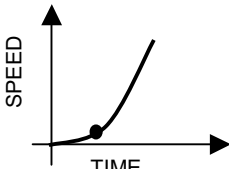
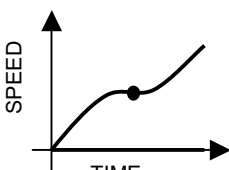
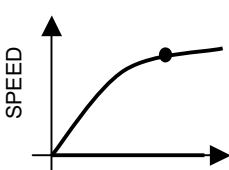
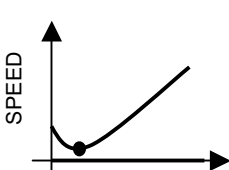
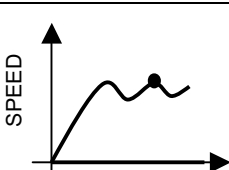
| Problem | Possible Cause | Solution |
|---|--|--|
|  | <ul style="list-style-type: none"> Inverter does not start because it does not receive a RUN signal. | <ul style="list-style-type: none"> Ensure that the inverter receives a RUN signal from the burner fan motor output daughter board fitted on the NX6100 control. |
|  | <ul style="list-style-type: none"> Inverter has a slow start. Non-linear output from inverter or inverter's PID is enabled | <ul style="list-style-type: none"> Ensure that the inverter's slow start feature is disabled. Check that the inverter's output is selected to be linear, and that the inverter's own PID loop is disabled. |
|  | <ul style="list-style-type: none"> Current limit reached Noise | <ul style="list-style-type: none"> Slow down the inverter by increasing its acceleration / deceleration time settings. Check cable screens. |
|  | <ul style="list-style-type: none"> Current limit reached. Non-linear output from inverter or inverter's PID is enabled. | <ul style="list-style-type: none"> Slow down the inverter by increasing its acceleration / deceleration time settings. Check that the inverter's output is selected to be linear, and that the inverters own PID loop is disabled. |
|  | <ul style="list-style-type: none"> Fan failed to stop before restart. | <ul style="list-style-type: none"> Increase the inverter stop time by increasing option parameter 09.3 on the NX6100 series control3. |
|  | <ul style="list-style-type: none"> Control is unstable | <ul style="list-style-type: none"> Adjust option parameters 9.0 and 9.2 on the NX6100 control to reduce accuracy & slow down control response. Check Option parameter 9.4 matches the acceleration / deceleration time programmed into the VSD. VSD is current limiting. Increase acceleration / deceleration time in VSD and option parameter 9.4. |

In extreme cases, it may be necessary to increase the inverter error tolerance to prevent non-volatile lockouts caused by positioning faults (set option 9.1 = 1). **This must only be changed if an inverter error of ± 55 will not cause unsafe combustion**



9.7 Oxygen measurement and trim

| Problem | Possible cause | Suggested action |
|--|--|---|
| Oxygen display not available. | No oxygen probe interface unit serial number entered. | Enter serial number into option parameter 30.0 |
| No inlet temperature display | No inlet temperature unit serial number entered. | Enter serial number into option parameter 35.0 |
| Inlet or flue temperature display flashes 'Hi' | Inlet air temperature sensor / O2 probe not installed and wired correctly. | Check wiring. |
| No efficiency display or efficiency incorrect. | No oxygen display. No inlet temperature display. No calorific value for the current fuel been entered into 35.X? | See 'No oxygen display' See 'No inlet temperature display' Enter the value for the fuel in use. |
| Oxygen display shows '----' | Probe not heated up yet, or other probe fault. | Check EK45. Check EK72 – must be above 600°C to work. |
| Oxygen trim will not work | Trim is not operative. Boiler just fired up. Probe calibration values not entered correctly. Probe not heated up yet. Probe installed incorrectly. Set to monitor only. Probe in calibration. Trim being reset. Trim limits set to 0.0% of flow. Trim integral gain set to zero. Commissioning data missing. | Use EK45 and 46 to decide if trim is operative. Check that option 30.5 =1. Check option parameter 31.1 to 31.4. Wait for the boiler transport time (after ignition). Wait for modulation. Re enter values (options 320.1, 320.2) Check EK75 – must be above 600°C to work. Check wiring. Check option parameter 30.5 set to 1. Check option parameter 30.6 set to 0. Check option parameter 30.8 set to 0. Check option parameters 32.X. Check option parameters 33.X are non zero. Check oxygen and flow values been entered for all profile points in the firing range. |

PID Tutorial

PID Adjustment

The NX6100 utilizes an advanced algorithm in order to maintain setpoint over a variety of load conditions. This three term PID can be infinitely adjusted to suit almost any application. The operator should have a basic understanding of the relationship between the three terms - proportional, integral and derivative.

Proportional



Typical older modulating systems employ only proportional control. This would be similar to the slide wire type found on most steam boilers. When using only a proportional control the system rarely achieves setpoint as the burner firing rate is lowered as the pressure comes up. At some point the input meets the actual demand and the pressure no longer raises or lowers, thus an offset between desired setpoint and actual operating pressure occurs. The only time the pressure and setpoint are the same is if the actual load equals the lowest firing rate of the burner, this is rare. An example of proportional only set up might be; Setpoint is 100 PSI, proportional range is 10 PSI. That is low fire is at 100 PSI, high fire is at 90 PSI with a 1:1 relationship in between, e.g.: 95PSI equals 50% rate.

Integral

If the integral term is turned on, the control compares the actual pressure against setpoint at an adjustable interval. If there is an offset, the firing rate is increased by a small percentage until the next interval. This will continue until the pressure equals the setpoint. The same routine occurs as the pressure rises above the setpoint. Too much or too little integral will cause over and undershoot of the setpoint. Integral is set in seconds per repeat in the NX6100.

For example, if the P were set at 10 psi with a boiler set point of 100 psi, the burner would first remain at high fire until the pressure reached 90 psi, and then start to modulate down. If the load was equal to 50% firing rate, the pressure would stall at 95 psi. Adding an "I" value of 10 would ramp the output up to 100% (high fire) in 10 seconds, assuming no change in the boiler pressure. Setting an "I" value of 300 increases the output up to 100% (high fire) in 5 minutes (300 seconds). As the boiler reaches setpoint, the same timing effect occurs above setpoint. Therefore, too much "I" can cause over/under shoot as loads change. Too little "I" may cause rapid hunting.

Derivative

Enabling the derivative has the effect of sensing the rate of change in the process variable (pressure or temperature) and increasing or holding up the firing rate output despite the integral term. This in effect amplifies the output to anticipate the effect of a sudden change in load demand. Derivative acts inversely when the setpoint is exceeded. Derivative is set in seconds on the NX6100.

Start with a P value of about 10% of setpoint, and an I value of 20 seconds with a D value of 5 seconds. After observing the operation through normal load swings, adjust each value, usually one at a time, and observe the results. When making a change it is recommended the value be doubled or halved to determine which direction you need to go. Bear in mind, the burner should not continuously hunt or swing to maintain the desired setpoint. It is normal for a slight over and undershoots of setpoint during serious load changes.

The values for the PID's are found at option parameters 21.2, 21.3 and 21.4 for setpoint 1 (PID1), and 22.2, 22.3 and 22.4 for setpoint 2 (PID2). These values are adjustable using the **Site Passcode 154**.

11 Combustion Profile Setup Guideline

It is safe to say that most burners do not have fuel and air control devices that have linear flow characteristics. When commissioning the Fireye Nexus/PPC parallel positioning system, the following procedure will help assure the maximum benefit will be realized. Before starting the installation, the commissioning engineer should try to verify the maximum combustion air damper (flow) position so as to know the "target" high fire position. This can be done by rotating the original jack shaft before it is removed and measuring the air damper opening. If possible, it should be marked for reference.



There are 24 points available for creating a profile, P0 (closed/off) to P23 (high fire). The first three positions, P0, P1&P2 are required to reach ignition which may or may not be the same as low fire (P3). After establishing a good low fire and entering the values at P3, the display will now indicate P4 with the drives at the P3 position. At this time the main air drive or drives should be increased a minimum of one degree or until the observed oxygen level increases approximately 1.0 to 2%, **do not press enter at this time**. At this point the fuel drive should be increased slowly to bring the oxygen level back down to the desired level and entered at this time. Following this procedure from low to high fire will yield a relatively linear profile. That is to say, each position will increase the fuel and air flows by nearly equal amounts from low to high fire, thus making the profile somewhat linear. This will aid in setting up O2 trim.

The NX6100's **Engineers Key 44 (see section 8.8)** displays the actual O2 value of the Fireeye oxygen probe when fitted. It should be noted that the reading of the Fireeye probe will be between 1 and 1.5% **lower** than most portable combustion analyzers. This is normal and due to the difference between wet and dry samples. Bear in mind the NX6100 will trim to the value of the Fireeye probe, not to the value of a portable analyzer.

For example:

| <u>Position</u> | <u>Air Drive</u> | <u>Fuel Drive</u> | <u>Observed O2%</u> | <u>Increased O2%</u> |
|-----------------|------------------|-------------------|---------------------|----------------------|
| P3 | 5.0 | 15.0 | 7.0 | 8.5 |
| P4 | 7.5 | 18.0 | 7.0 | 8.5 |
| P5 | 12.0 | 22.0 | 6.0 | 7.5 |
| P6 | 17.0 | 28.0 | 5.0 | 6.5 |
| P7 | 24.0 | 33.0 | 4.0 | 5.5 |
| P8 | 29.0 | 38.0 | 4.0 | 5.5 |
| P9 | 35.0 | 45.0 | 4.0 | 5.5 |
| P10 | 43.0 | 55.0 | 3.5 | 5.0 |
| P11 | 53.0 | 67.0 | 3.5 | 5.0 |
| P12 | 66.0 | 79.0 | 3.5 | 5.0 |
| P13 | 80.0 | 88.0 | 3.5 | High Fire |

NOTE: The angular change in the air drive position required to achieve the 1.0 to 2.0% increase in observed oxygen level may increase as the burner fires at higher rates. This is normal as the air “damper” will not likely be linear. When approaching high fire large increases in the air drive servomotor travel may be required to increase the oxygen reading by 1.0 to 2.0%. As a rule, this should be avoided as the burner is potentially “out of air” and in so doing, the effective input to the boiler will be negligible. This would also affect the operation of oxygen trim should this option be used.

12 Fireeye NX6100 Efficiency Calculations

Fireeye NX6100 controls can display calculated combustion efficiency.

For the displayed efficiency to be meaningful the correct values for Calorific Value and Hydro-Carbon Ratio for the fuel in use must be entered in the related Fireeye NX6100 option parameters.

Efficiency may be displayed as Net or Gross.



The calorific value of a fuel is the heat given out when unit quantity of the fuel is completely burnt, any fuel containing hydrogen has two calorific values, these being the gross or higher calorific value and the net or lower calorific value.

The gross calorific value is the heat given out when unit quantity of fuel at 15.6 °C (60 °F) is completely burnt and the products of combustion are cooled to 15.6 °C (60 °F), as such any steam present in the products of combustion due to the burning of the hydrogen will be condensed to water, giving up its latent heat of vaporization and some of its sensible heat loss.

This heat recovery is not possible under practical conditions and the net value is approximately the gross value less this quantity of heat which is usually taken at 2.45 MJ/Kg of steam formed.

Therefore if gross efficiency is required, gross calorific value is used and the latent heat of vaporization due to any steam present in the products of combustion is taken as a loss in the efficiency calculation.

However, if net efficiency is required, net calorific value is used and therefore the latent heat of vaporization due to any steam present in the products of combustion is already taken into account, so the latent heat loss in the efficiency equation is set to zero.

In addition when considering gross efficiency it is normal to also take account to the boiler radiated heat loss. This will be a fixed heat loss from the boiler shell in the order of 1% to 3% of the boiler high fire output, which if the burner is operating with say a 6 to 1 turn down would equate to a 6% to 18% loss at low fire.

Comparison of Fireeye NX6100 with Hand Held Equipment

When comparing the efficiency as displayed by the NX6100 control and other equipment it is important to ensure the same parameters are being used by both units.

- 1) Ensure the efficiency is selected to be either net or gross in both units, hand held equipment usually uses net since it is rare for hand held equipment to have knowledge of the boiler firing rate to include the radiated heat loss.
- 2) Ensure the same calorific value is being used by both units.
- 3) Ensure the same value for hydro-carbon ratio is being used by both units.
- 4) Ensure the ambient (inlet) temperature being measured by the hand held is physically at the air intake to the burner, as it should be for the NX6100. If the hand held equipment does not measure the inlet temperature, ensure the value it is using for ambient air temperature is representative of the application.
- 5) Ensure the flue temperature and oxygen value are being measured at the same location in the flue to reduce the possibility of errors being introduced due to stratification of the flue gas.
- 6) Fireeye O₂ probes measure oxygen in the flue without extracting and drying flue gases. If attempting to compare the oxygen values being measured by the NX6100 and a hand held equipment ensure the value being given by the hand held is corrected from a dry to a 'wet' value, as it will almost certainly be measured as a 'dry' value. The water being removed to prevent damage to the sensor cells in the hand held equipment.

When comparing the values of efficiency displayed by the NX6100 equipment and hand held equipment, **first** check that the following values are the same or very close:

- 1) Inlet temperature.
- 2) Flue gas temperature.
- 3) Calorific value
- 4) Hydro-carbon ratio.



- 5) Oxygen value (after making correction for dry to wet on the hand held).
- 6) Selection of net or gross.
- 7) If a radiated heat loss value is being included ensure the hand held equipment has corrected the value for the current firing rate of the burner.

Other points to remember:

In a typical package boiler radiation losses are usually in the order of 3%, blow down losses typically 2% and flue gas losses 15% to 20%.

Giving a typical overall efficiency of $100 - 3 - 2 - 20 = 75\%$.

The major area for attention to improve boiler efficiency is the flue gas losses, with the object of minimizing excess air, within the bounds of safe and reliable boiler operation. O2 Trim is the best tool for ensuring consistent optimum combustion and minimization of excess air.

The NX6100 ensures consistent fuel: air ratios.

The Fireeye O2 Trim option continuously compensates for changes that affect efficient combustion due to such variables as: viscosity of liquid fuels, density of gaseous fuels, changes in temperature of fuels, changes in gas and oil pressures, worn and damaged burners, dirty burners, scaling of boiler tubes, ambient temperature, barometric pressure and tramp air.



13 Typical Wiring Diagrams

System connection drawing

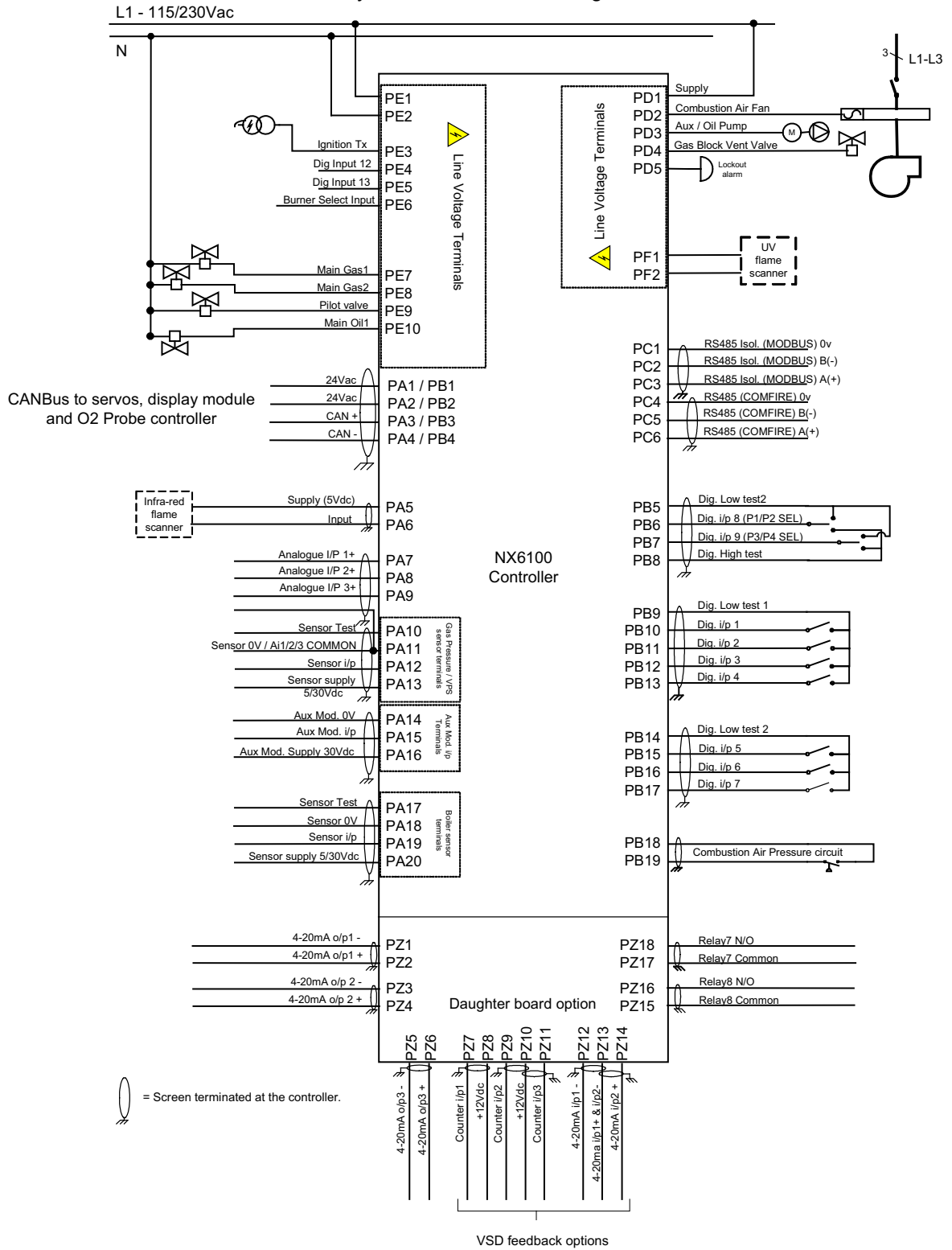



NOTICE

When Fireeye products are combined with equipment manufactured by other and/or integrated into systems designed or manufactured by others, the Fireeye warranty, as stated in its General Terms and Conditions of Sale, pertains only to the Fireeye products and not to any other equipment or to the combined system or its overall performance.

WARRANTIES

FIREYE guarantees for *one year from the date of installation or 18 months from date of manufacture* of its products to replace, or, at its option, to repair any product or part thereof (except lamps and photocells) which is found defective in material or workmanship or which otherwise fails to conform to the description of the product on the face of its sales order. **THE FOREGOING IS IN LIEU OF ALL OTHER WARRANTIES AND FIREYE MAKES NO WARRANTY OF MERCHANTABILITY OR ANY OTHER WARRANTY, EXPRESS OR IMPLIED.** Except as specifically stated in these general terms and conditions of sale, remedies with respect to any product or part number manufactured or sold by Fireeye shall be limited exclusively to the right to replacement or repair as above provided. In no event shall Fireeye be liable for consequential or special damages of any nature that may arise in connection with such product or part.



FIREYE
3 Manchester Road
Derry, New Hampshire 03038 USA
www.fireeye.com

NXOGTSD-6101
DECEMBER 18, 2008